

Conext™ ComBox

Installation and Configuration Manual



Copyright © 2014 Schneider Electric. All Rights Reserved. All trademarks are owned by Schneider Electric Industries SAS or its affiliated companies.

Exclusion for Documentation

UNLESS SPECIFICALLY AGREED TO IN WRITING, SELLER

(A) MAKES NO WARRANTY AS TO THE ACCURACY, SUFFICIENCY OR SUITABILITY OF ANY TECHNICAL OR OTHER INFORMATION PROVIDED IN ITS MANUALS OR OTHER DOCUMENTATION;

(B) ASSUMES NO RESPONSIBILITY OR LIABILITY FOR LOSSES, DAMAGES, COSTS OR EXPENSES, WHETHER SPECIAL, DIRECT, INDIRECT, CONSEQUENTIAL OR INCIDENTAL, WHICH MIGHT ARISE OUT OF THE USE OF SUCH INFORMATION. THE USE OF ANY SUCH INFORMATION WILL BE ENTIRELY AT THE USER'S RISK; AND

(C) REMINDS YOU THAT IF THIS MANUAL IS IN ANY LANGUAGE OTHER THAN ENGLISH, ALTHOUGH STEPS HAVE BEEN TAKEN TO MAINTAIN THE ACCURACY OF THE TRANSLATION, THE ACCURACY CANNOT BE GUARANTEED. APPROVED CONTENT IS CONTAINED WITH THE ENGLISH LANGUAGE VERSION WHICH IS POSTED AT WWW.SCHNEIDER-ELECTRIC.COM.

Document Number: 975-0679-01-01 **Revision:** Revision E **Date:** June 2014

Product Part Number: 865-1058

Contact Information www.schneider-electric.com

For country details please contact your local Schneider Electric Sales Representative or visit the Schneider Electric website at:

<http://www.sesolar.com/where-to-buy/>

Information About Your System

As soon as you open your product, record the following information and be sure to keep your proof of purchase.

Serial Number _____

Product Number _____

Purchased From _____

Purchase Date _____

About This Guide

Purpose

The purpose of this Owner's Guide is to provide explanations and procedures for installing, operating, configuring, maintaining, and troubleshooting the Conext ComBox Communication and Monitoring Device.

Scope

The Guide provides safety guidelines, planning, and setup information, procedures for installing the Conext ComBox, as well as information about configuring, monitoring, and troubleshooting the unit. It does include information on how to use other Schneider Electric products.

Firmware Revision

Some Conext ComBox features and functions described in this guide may be incorporated with later firmware versions. This manual is valid for Conext ComBox version 01.00 and above. To view the firmware version on your product, see the Conext ComBox Status Information in the web user interface.

Audience

The Guide is intended for use by anyone who plans to construct, install, or operate a system involving the Conext ComBox. The information in this manual is intended for qualified personnel. Qualified personnel have training, knowledge, and experience in:

- Installing electrical equipment
- Applying all applicable installation codes
- Analyzing and reducing the hazards involved in performing electrical work
- Changing any TCP/IP-related settings

Organization

This Guide is organized into five chapters and an appendix.

Chapter 1, "Overview", describes physical features of the Conext ComBox and introduces the user interface.

Chapter 2, "Installation", describes how to install, wire, and connect the Conext ComBox to your network.

Chapter 3, "Configuration", describes how to configure and change device settings, manage data logs, import and export data, and upgrade firmware.

Chapter 4, "Monitoring", describes how to monitor LED indicator lights (LEDs), system and device levels, and create historical views.

Chapter 5, "Troubleshooting", describes how to interpret events and alerts.

Appendix A, "Specifications", contains the electrical, mechanical and environmental specifications for the Conext ComBox.

Conventions Used

The following conventions are used in this guide.

⚠ DANGER

DANGER indicates an imminently hazardous situation, which, if not avoided, will result in death or serious injury.

⚠ WARNING

WARNING indicates a potentially hazardous situation, which, if not avoided, can result in death or serious injury.

⚠ CAUTION

CAUTION indicates a potentially hazardous situation, which, if not avoided, can result in moderate or minor injury.

NOTICE

NOTICE indicates important information that you need to read carefully.

Abbreviations and Acronyms

DHCP - Dynamic Host Configuration Protocol

LED - Light Emitting Diode (used for indicator lights)

SELV - Safety Extra Low Voltage

SNTP - Simple Network Time Protocol

TCP/IP - Transmission Control Protocol/Internet Protocol

Related Information

Related Products

For more information about related products, refer to:

Conext XW+ Inverter/Charger Owner's Guide

Conext Solar Charge Controller Owner's Manual

Conext Automatic Generator Start Owner's Guide

Conext System Control Panel Owner's Guide

Conext SW Inverter/Charger Owner's Guide

Conext MPPT 80 600 Solar Charge Controller Operation Guide

Conext MPPT 60 150 Solar Charge Controller Operation Guide

Grid-Tie-AUS Solar Inverter Owner's Manual

Conext TX Solar Inverter Owner's Manual

You can find more information about Schneider Electric as well as its products and services at **www.schneider-electric.com**.

For specific information regarding Solar products go to **www.SEsolar.com**

Modbus Revision E Maps

Modbus maps are not included in this guide. They are available at **<http://www.sesolar.com/product/conext-combox/>**. The following Modbus maps are used with the Conext ComBox:

- Conext SW Modbus Map (503-0244-01-01)
- Conext XW Modbus Map (503-0246-01-01)
- Conext Automatic Generator Start Modbus Map (503-0247-01-01)
- Conext MPPT 60 150 Modbus Map (503-0248-01-01)
- Grid-Tie/TX Modbus Map (503-0250-01-01)
- Conext System Control Panel Modbus Map (503-0251-01-01)
- Conext MPPT 80 600 Modbus Map (503-0252-01-01)
- Conext Modbus Converter/ComBox Modbus Map (503-0253-01-01)

Important Safety Instructions

READ AND SAVE THESE INSTRUCTIONS - DO NOT DISCARD

This guide contains important safety instructions for the Conext ComBox Communication and Monitoring Device that must be followed during operation and troubleshooting. **Read and keep this Owner's Guide for future reference.**

Read these instructions carefully and look at the equipment to become familiar with the device before trying to install, operate, service or maintain it. The following special messages may appear throughout this bulletin or on the equipment to warn of potential hazards or to call attention to information that clarifies or simplifies a procedure.



The addition of this symbol to a “Danger” or “Warning” safety label indicates that an electrical hazard exists which will result in personal injury if the instructions are not followed.



This is the safety alert symbol. It is used to alert you to potential personal injury hazards. Obey all safety messages that follow this symbol to avoid possible injury or death.

DANGER

HAZARD OF ELECTRIC SHOCK

- Read all instructions, cautionary markings, and all other appropriate sections of this manual before installing, operating, troubleshooting or performing maintenance on the Conext ComBox.
- Exercise extreme caution at all times to prevent accidents.
- These instructions are for use by qualified installers only.

Failure to follow these instructions will result in death or serious injury.

⚠ ⚠ DANGER

HAZARD OF ELECTRIC SHOCK AND FIRE

- Connect only to Safety Extra Low Voltage (SELV) circuits and power sources.
- All wiring must be done by qualified personnel to ensure compliance with all applicable installation codes and regulations.
- For Indoor Use Only.
- Do not disassemble. No user serviceable parts inside.

Failure to follow these instructions will result in death or serious injury.

⚠ WARNING

HAZARD OF PHYSICAL INJURY AND UNEXPECTED OPERATION

Refer to the Owner's Guide for more detailed information when making any changes to settings or sending commands. Commands sent to this device may affect other components in the system. Ensure that anyone working with the system is aware of the result of your changes before sending a command.

Failure to follow these instructions can result in death or serious injury.

NOTICE**EQUIPMENT DAMAGE**

- All cables connected to the Conext ComBox must run indoors and not be susceptible to lightning strikes.
- Turn OFF all devices before connecting cables. The Conext ComBox does not have an ON/OFF switch.
- Do not connect an Ethernet cable from the Conext ComBox to the WAN/MODEM port on the network router.
- Do not connect an Ethernet cable plug into a Xanbus port on the Conext ComBox.
- Do not connect a Xanbus RJ-45 cable plug into the 10/100 Ethernet port of the Conext ComBox.
- Do not connect any port on the Conext ComBox to an outside line or to a public telecommunication network.
- Ensure that the device connected on the Xanbus network is in standby mode before changing settings. Do not change any settings unless you are familiar with the device.
- Changes to any TCP/IP-related settings should only be performed by a qualified IT professional.

Failure to follow these instructions can damage equipment or affect network performance.

NOTICE**EQUIPMENT DAMAGE**

- Do not disassemble the Conext ComBox.
- See Warranty for instructions on obtaining service.
- The Conext ComBox contains no user serviceable parts. Attempting to service the Conext ComBox yourself will void your warranty.

Failure to follow these instructions can damage equipment.

Note: This device can be configured to connect to the Internet using port-forwarding in your network router's settings. There is a security risk in port-forwarding unencrypted network traffic over a public network (Internet). Use of a VPN or a secure tunnel to route Conext ComBox communication via the Internet is recommended.

Contents

Important Safety Instructions- - - - - -	vii
---	------------

1 Overview

Overview - - - - -	1-2
Compatible Xanbus™ Components - - - - -	1-2
Physical Features - - - - -	1-3
Data Ports and Reset Button - - - - -	1-3
LED Indicator Lights (LEDs) - - - - -	1-4
Communication and Power Ports - - - - -	1-5
Types of Conext ComBox Networks - - - - -	1-6
Conext ComBox on a Local Area Network (LAN) - - - - -	1-6
Conext ComBox with Remote Access - - - - -	1-7
Conext ComBox as a Modbus Slave (RS 485) - - - - -	1-8
Conext ComBox as a Modbus Master (RS 485) - - - - -	1-8
Power Sources for the Conext ComBox - - - - -	1-9
User Interface - - - - -	1-10
Conext ComBox Settings Buttons - - - - -	1-10
Other Buttons - - - - -	1-11
System Scheduled Maintenance - - - - -	1-12

2 Installation

Choosing a Location - - - - -	2-2
Materials and Tools Required - - - - -	2-3
Materials List - - - - -	2-3
Additional Material and Tools - - - - -	2-3
Mounting the Conext ComBox - - - - -	2-4
Wall Mount - - - - -	2-4
DIN Rail Mount - - - - -	2-6
Wiring the RS 485 Modbus Connector for Data Communication to the Conext ComBox - - - - -	2-7
Wiring the Dry Contact Connector - - - - -	2-9
Connecting the Conext ComBox to an Ethernet Network - - - - -	2-10
Turning On the Conext ComBox- - - - -	2-12
Connecting the AC/DC Power Adapter - - - - -	2-13
Wiring the RS 485 Modbus Connector for Power to the Conext ComBox - - - - -	2-14

Finding the Conext ComBox on the Network- ----- 2-16
Logging in to the Conext ComBox Web User Interface Using a USB Thumb Drive- ----- 2-17

3 Configuration

Configuration Steps ----- 3-2
Logging In- ----- 3-3
Changing the Admin Password ----- 3-5
Changing the Time- ----- 3-6
Changing E-Mail Settings ----- 3-8
Connecting the Conext ComBox to the Xanbus Network ----- 3-10
Changing Conext ComBox Settings- ----- 3-13
 General Settings ----- 3-14
 Change User Password Settings ----- 3-15
 Change Admin Password Settings ----- 3-15
 TCP/IP Settings ----- 3-16
 E-mail Settings ----- 3-16
 E-mail Reporting ----- 3-17
 Web ----- 3-19
 FTP ----- 3-20
 FTP Logger ----- 3-21
 Dry Contact Relay ----- 3-22
 Suppress Device Faults/Warnings ----- 3-22
 Xanbus Communications ----- 3-23
 Modbus Communications ----- 3-24
 Modbus Byte Order ----- 3-25
 Modbus Address List ----- 3-26
 Modbus Address Enumeration ----- 3-28
 System Diagram ----- 3-29
 Conext Insight Web Portal ----- 3-29
 Multi Cluster ----- 3-30
 Curtailment ----- 3-31
Modbus Master Configuration ----- 3-31
 Communication Setup ----- 3-32
 Automated Modbus Device Discovery ----- 3-32
 Manually Add Device ----- 3-33

Modbus Power Meters - - - - -	3-34
Modbus Device List - - - - -	3-34
Resetting the Conext ComBox to Factory Settings- - - - -	3-35
Changing Device Settings- - - - -	3-36
Cascading Parameters and Copy Configuration Features - - - - -	3-38
Using Cascading Parameters - - - - -	3-38
Using Copy Configuration - - - - -	3-39
Upgrading Firmware- - - - -	3-42
Clearing Conext ComBox Internal Firmware Memory - - - - -	3-42
Installing Conext ComBox Upgrades from a Thumb Drive - - - - -	3-43
Installing Conext ComBox Upgrades Remotely - - - - -	3-45
Installing Xanbus Device Upgrades - - - - -	3-49
Conext ComBox Master-Slave Configuration- - - - -	3-50
Overview - - - - -	3-50
4 Monitoring	
Monitoring LEDs- - - - -	4-2
Startup - - - - -	4-2
Operating Mode - - - - -	4-3
Monitoring Conext ComBox Status Information - - - - -	4-4
Daily Summary Plots - - - - -	4-5
PV & AC Daily Summary Plot - - - - -	4-6
Battery Bank Daily Summary Plot - - - - -	4-6
Navigating and Zooming Plots - - - - -	4-7
Remote Monitoring With Conext Insight - - - - -	4-7
5 Troubleshooting	
Viewing Xanbus Device Faults and Warnings - - - - -	5-2
Viewing ComBox Events - - - - -	5-3
Viewing System Faults and Warnings - - - - -	5-3
Browsing Event and Fault Log Files - - - - -	5-4
Browsing Energy Log Files - - - - -	5-5
Troubleshooting - - - - -	5-7
Managing Data Logs - - - - -	5-8
Accessing and Downloading Log Files - - - - -	5-10
A Specifications	
Electrical Specifications - - - - -	A-2
Communication Interfaces - - - - -	A-2
Data Interfaces - - - - -	A-2
Power Supply (SELV on all sources) - - - - -	A-2
Memory - - - - -	A-2

General Specifications-	A-3
Features-	A-3
Regulatory Approvals	A-4
Schneider Electric Products that work with the Conext ComBox	A-4
Physical Dimensions	A-5
Front View	A-5
Side View	A-5
Bottom View	A-6
Back View	A-6

1

Overview

Chapter 1 describes the features of the Conext ComBox and provides an overview of its physical features and web user interface. It includes:

- Overview
- Compatible Xanbus™ Components
- Physical Features
- Types of Conext ComBox Networks
- Power Sources for the Conext ComBox
- User Interface
- System Scheduled Maintenance

Overview

The Conext ComBox Communication and Monitoring Device is a multi-function communication device that provides an overall view of system performance for residential power monitoring systems. It also provides a communications gateway between a network of Xanbus™-enabled devices and Modbus devices.

Operators can configure the system and devices, monitor performance, and access data logs through the web-based user interface. A Modbus interface can link the Conext ComBox with third-party software packages and building management systems, and a Micro-SD card slot provides additional data storage capability.

Other features of the Conext ComBox include:

- Compatibility—connects directly to Xanbus-enabled devices
- Real-time clock—keeps time for the entire system
- Non-volatile memory—preserves the latest Conext ComBox settings if power is interrupted or network communication is disrupted.
- Firmware storage and upgrade capability—uses the Conext ComBox to upgrade or downgrade firmware for Xanbus-enabled devices on the network.
- Cloud storage capability—Save and synchronize settings with the Conext Insight cloud service.

Compatible Xanbus™ Components

The Conext ComBox works with several Schneider Electric products including:

- Conext XW+ Inverter/Chargers
- Conext System Control Panel (SCP)
- Conext Automatic Generator Start (AGS)
- Conext SW Inverter/Chargers
- Conext MPPT 60 150 Solar Charge Controllers
- Conext MPPT 80 600 Solar Charge Controllers
- Conext Battery Monitor
- Conext TX Grid-Tie Solar Inverters
- Grid-Tie-AUS Series Grid-Tie Solar Inverters

Note: For details on specific models supported, see the “Specifications” section. The Conext ComBox supports up to a maximum of 20 devices on a Xanbus network depending on the device types.

Physical Features

The following illustration shows the Conext ComBox. The tables in the following sections contain descriptions of the connectors, indicators, and data ports on the Conext ComBox.



Data Ports and Reset Button

The data ports and reset are located in a flip panel at the top of the Conext ComBox. Their functions are listed in the following table.

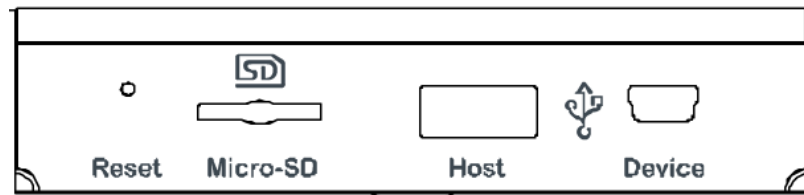

Item	Description
Reset	The Reset pinhole is used to restore factory settings or clear internal firmware memory. See “Resetting the Conext ComBox to Factory Settings” and “Shutting down the Conext ComBox” on page 3–14.
Micro-SD	The Micro-SD data port is used with a Micro-SD card to extend Conext ComBox memory for data logging.
Host	The Host USB data port is used for uploading firmware upgrades into the device - a thumb drive or equivalent mass storage device can be used. See “Clearing Conext ComBox Internal Firmware Memory”.

Device | The Device Mini-USB data port is used for transferring files from the Conext ComBox to a PC.

LED Indicator Lights (LEDs)

The Power LED flashes slowly (2 flashes per second) during the Conext ComBox application loading and flashes quickly during application initialization. The other LEDs light up one by one as the startup progresses. Once the Conext ComBox is ready, the power LED is on and other LED's behave as described below. See "Monitoring LEDs" for more information.

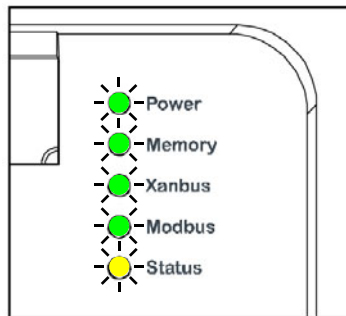

Item	Description
Power	Green LED. The Conext ComBox is powered and ready to communicate when on.
Memory	Green LED. Device is logging data to internal memory when flashing.
Xanbus	Green LED. Device is actively communicating or transferring data with the Xanbus network when on.
Modbus	Green LED. Each flash indicates that the Conext ComBox received a message from the Modbus.
Status	Amber LED. Devices on the Conext ComBox system have events or alerts when on.

Communication and Power Ports

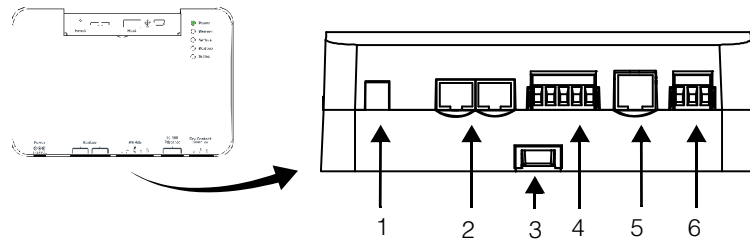

Item	Description
1	Power port. Use an AC/DC power adapter connected to a wall outlet to provide power to the Conext ComBox.
2	Xanbus ports. Plug in a CAT5 cable from Xanbus-enabled devices for communications and/or power to the Conext ComBox.
3	DIN rail sliding catch. Slide up/down to lock/release the Conext ComBox to a DIN rail.
4	RS 485 Modbus port. Use the RS 485 Modbus connector from a Modbus device for communications and 24V power terminals to the Conext ComBox.
5	10/100 Ethernet port for CAT5 cable only. Use to connect to a DHCP-enabled network router.
6	Dry Contact port. Used for signalling with SELV (Safety Extra Low Voltage) device. It does not provide power to the Conext ComBox.

See the “Installation” section for more detail on these ports.

Types of Conext ComBox Networks

The Conext ComBox can interface with different LAN devices using wired or wireless connections, so you can configure your Xanbus devices and monitor your power system performance. There are three communication network options:

- Conext ComBox on a Local Area Network (LAN)
- Conext ComBox with Remote Access
- Conext ComBox as a Modbus Slave (RS 485)
- Conext ComBox as a Modbus Master (RS 485)

Conext ComBox on a Local Area Network (LAN)

When the Conext ComBox is part of a LAN, you can access the Conext ComBox web user interface from a computer on the same LAN or through a wireless or wired LAN connection. An Ethernet connection is required between the Conext ComBox and a router and computer for configuring the Conext ComBox.

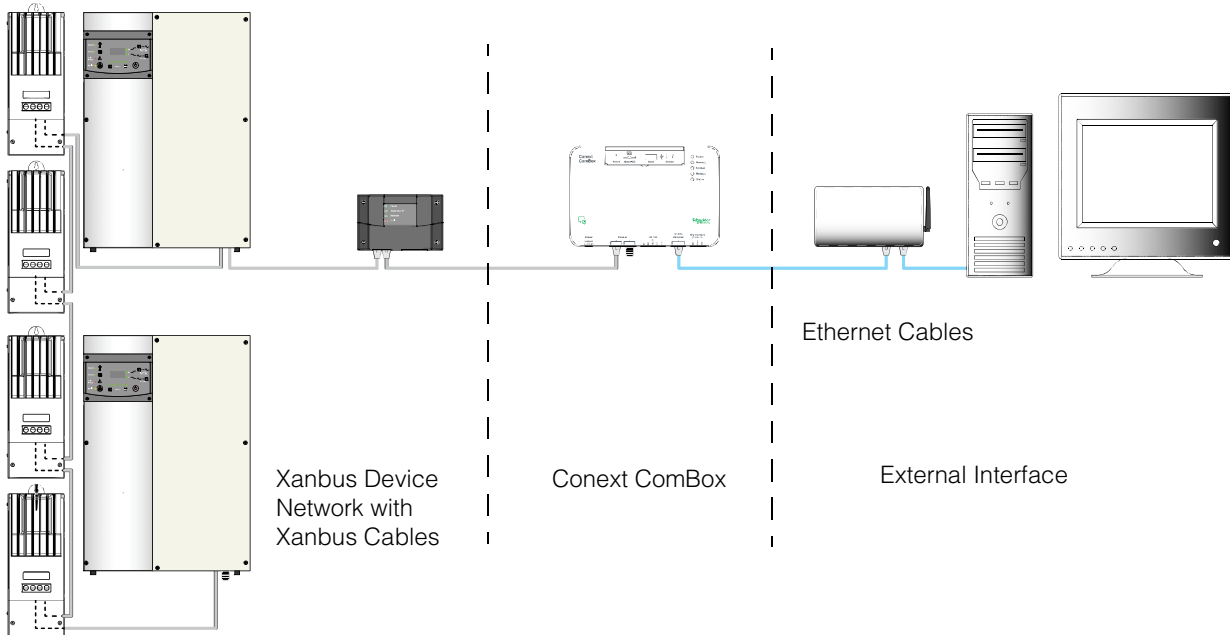

Conext ComBox with Remote Access

You can access the web user interface for the Conext ComBox from a remote computer using the Internet. The Conext ComBox must be connected to a router. The router firewall settings must allow port forwarding, which allows the remote computer to access the Conext ComBox using the router's IP address and the port number for the Conext ComBox.

Note: There is a security risk in port forwarding unencrypted network traffic over a public network (Internet). It is recommended you use a VPN or a secure tunnel to route Conext ComBox communication via the Internet.

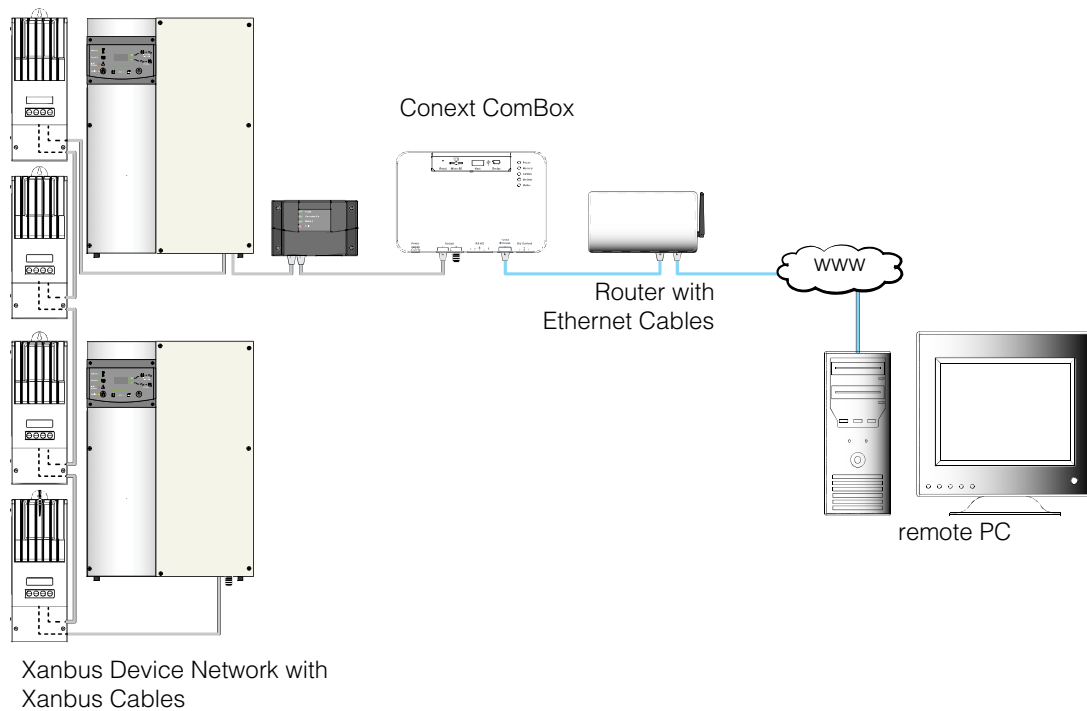

Conext ComBox as a Modbus Slave (RS 485)

You can use the Conext ComBox as a Modbus slave where performance data can be sent to a master device, such as a Programmable Logic Controller (PLC) or Supervisory Control and Data Acquisition (SCADA) system through an RS 485 connection. You can also configure the system devices from the master device.

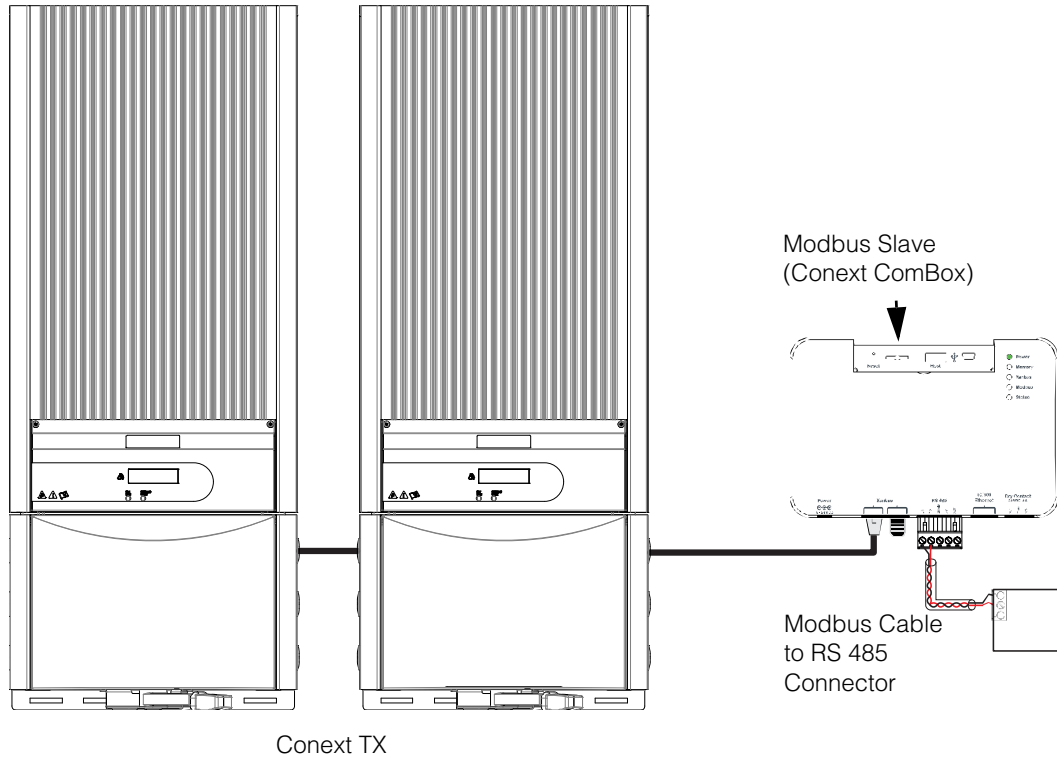

Conext ComBox as a Modbus Master (RS 485)

The Conext ComBox can be used as a Modbus master to gather readings from devices such as power meters. When enabled, these devices will be shown on the Home screen as a read-only display next to the associated section (Battery, Loads, Grid, or Solar).

Modbus Master Settings can be found under the Configuration menu for both Master and slave ComBoxes.

Power Sources for the Conext ComBox

The Conext ComBox consumes an average of 2 W under most operating conditions and up to 10 W maximum. The power sources connected to the Conext ComBox must be capable of providing this power requirement.

There are three power sources for the Conext ComBox:

- AC/DC power adapter (supplied)
- Xanbus-enabled device via CAT5 or CAT5e cable (Xanbus cable)
- 24 V DC power input connections on the RS 485 Modbus connector

All three sources can be used alone or simultaneously. Typically, the AC/DC power adapter (supplied) is used as a primary source with either a Xanbus or RS 485 Modbus connection as secondary sources. See the following diagram for connection locations.

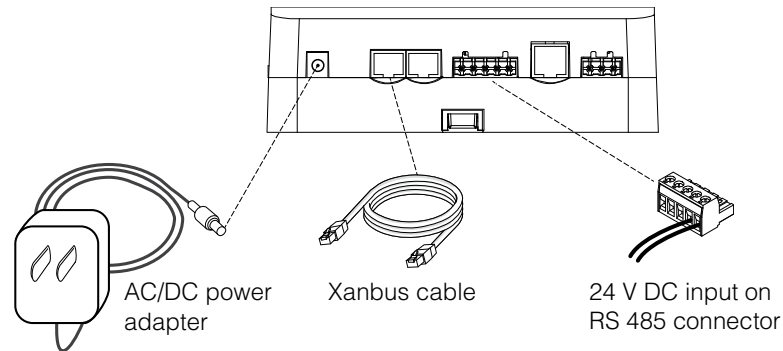

⚡ ⚠ DANGER

HAZARD OF ELECTRIC SHOCK AND FIRE

Connect only to Safety Extra Low Voltage (SELV) circuits and power sources.

Failure to follow these instructions will result in death or serious injury.

Safety Extra Low Voltage (SELV) is a designation that refers to a circuit in which the voltages within the circuit and from the circuit to ground have values that are not a shock hazard, under both normal and single fault conditions. In the Conext ComBox, the SELV circuits and their intended connections are:

- The supplied AC/DC power adapter connected to the power port of the Conext ComBox.
- Xanbus communications and power which come from SELV circuits on Xanbus-enabled Schneider products.
- 24 V DC power input connections which must be SELV and are connected to the Conext ComBox via the RS 485 Modbus connector.
- SELV Ethernet circuits or Class 2 circuits (Class 2 is a 24V, 100VA limited circuit).
- An external SELV circuit connected via the Dry Contact connector (see “Wiring the Dry Contact Connector” on page 2–9).

User Interface

This section describes the elements of the web-based user interface for the Conext ComBox. This interface is used to check the status of the Conext ComBox, configure, monitor and log data for your network, and perform upgrades. The menu bar contains icons for all functions plus home, close and setup icons. You can also link to the Schneider Electric website.

To access the web user interface, log in with a user name and password. For more details see “Logging In” on page 3–3.

Web browsers

Correct operation of the web interface has been verified with the following browsers:







- Mozilla Firefox 12.x and later
- Microsoft Windows Internet Explorer 10.x or later
- Google Chrome 18.x and later
- Safari 5.x and later
- Android 3.0 (Honeycomb)







Other browsers have not been tested and may have varying degrees of compatibility with the Conext ComBox.

Note: JavaScript and cookies must be enabled in your Web browser for the interface to function.

Conext ComBox Settings Buttons





These buttons are found within the Conext ComBox Settings pages.

Item	Description
 	Saves a parameter's new value to the Conext ComBox.
	Recalls (or refreshes) a parameter's previous value that is still not saved (or that may have been changed by another device).
	Found in E-mail-related settings, the Conext ComBox sends information out via the e-mail system.
	Found only in the Network Time (SNTP) setting, this button performs a manual network time synchronization.
	Found only in General Settings, this button reboots the Conext ComBox.

	Found only in General Settings, this button shuts down the Conext ComBox.
	Captures the most up-to-date value from a parameter.
	Sets the time and date in the Conext ComBox.
	Sets the time zone in the Conext ComBox.
	Found only in FTP Logger Settings, this button sends a sample log file to an FTP site.
	Causes a physical indicator on the Xanbus device to flash, light up, or beep, depending on the device.
	Found only in Modbus Address List Settings, this button resets the Modbus addresses of Xanbus devices.

Other Buttons

These buttons are found in other Conext ComBox web user interface screens, such as Upload screens and dialog screens.

Item	Description
	Found in Firmware Uploads And Device Upgrades, this button uploads an upgrade file from a storage device to the Conext ComBox.
	Found in Firmware Uploads And Device Upgrades, this button initiates the device upgrade process for a Xanbus device.
	When visible this provides the option to cancel a prompted action.
	Enacts an action prompted by a dialog screen.
	Closes a user interface screen or pop-up window.

System Scheduled Maintenance

The Conext ComBox is unavailable for approximately three minutes at 3:05 AM daily. During this time, the Conext ComBox performs routine maintenance and does not respond to queries via any of its external interfaces, such as Modbus TCP, RS 485, Web Services, and Web Pages. Data logging is also suspended during this period.

Machine to Machine Communication

The Conext ComBox signals the start of the routine maintenance period to external communication devices one minute before the routine starts, by setting its "MAINTENANCE" Modbus register (at address 0x003D) to 1.

External communication devices should stop queries to the Conext ComBox for at least four minutes after detecting that the Conext ComBox's "MAINTENANCE" Modbus register is currently set to 1.

After the routine maintenance is completed, the "MAINTENANCE" Modbus register (at address 0x003D) is reset to 0.

2

Installation

Chapter 2 describes how to install, wire, and connect the Conext ComBox to your network. It includes:

- Choosing a Location
- Materials and Tools Required
- Mounting the Conext ComBox
- Wiring the RS 485 Modbus Connector for Data Communication to the Conext ComBox
- Wiring the Dry Contact Connector
- Connecting the Conext ComBox to an Ethernet Network
- Turning On the Conext ComBox
- Finding the Conext ComBox on the Network
- Changing the ComBox Language
- Logging in to the Conext ComBox Web User Interface Using a USB Thumb Drive

Choosing a Location

Choose a clean, dry, easily accessible location indoors.

If you mount the Conext ComBox on a wall, the recommended height is at eye-level so that you can clearly see the LEDs and have easy access to the data ports.

All the communication ports on the Conext ComBox are accessible from the bottom of the device when mounted on a wall or DIN rail. Clearance of at least 2 inches (50 mm) below the device is needed to allow for the bending radius of cables that connect to the Conext ComBox.

You should not run cables through conduits that can be exposed to lightning strikes. The following are recommended maximum cable lengths in a Conext ComBox system:

131 feet (40 m)	Total Xanbus network
328 feet (100 m)	Router to Conext ComBox
164 feet (50 m)	Modbus Master (RS 485) to Conext ComBox

DANGER

HAZARD OF ELECTRIC SHOCK AND FIRE

- Connect only to Safety Extra Low Voltage (SELV) circuits and power sources.
- All wiring must be done by qualified personnel to ensure compliance with all applicable installation codes and regulations.
- For Indoor Use Only.
- Do not disassemble. No user serviceable parts inside.

Failure to follow these instructions will result in death or serious injury.

Materials and Tools Required

Materials List

The following materials are supplied in the Conext ComBox package:

- Conext ComBox unit
- Conext ComBox Quickstart Guide
- Conext ComBox CD includes:
 - Device Discovery Tool
 - Conext ComBox Owner's Guide
- AC/DC power adapter (PN: 0J-921-0023-Z) with replaceable multi-plug for North America, Europe, Asia, UK
 - 5.5 mm diameter (outer, negative), 2.1 mm diameter (inner, positive) connector
 - 12 VDC (output), 1.5 ADC
- Dry contact connector
- RS 485 Modbus connector
- Ethernet cable (2 m)
- USB cable (1.8 m)
- Xanbus network terminator
- Two #6 wood screws with anchors

Additional Material and Tools

The following materials and tools are not supplied but are required to complete the installation:

- CAT5 or CAT5e network cable(s) for Xanbus connections - 6.5 feet (2 m) or longer
- Modbus network cables(s)
- Wire stripper
- Ferrules

For wall mount:

- Two #6 (or equivalent) mounting screws for non-drywall mounting
- Screwdriver set

For DIN rail mount:

- 35-mm "top hat" DIN rail (EN50022)
- Pliers
- Diagonal cutter or heavy duty scissors

Mounting the Conext ComBox

Wall Mount

To mount the Conext ComBox on a wall:

1. Choose the location for mounting the device.
2. Using the template in the Conext ComBox Quickstart Guide, mark the mounting holes on the wall with a pencil.
The holes must be at the same height and 4 7/16 inches (112 mm) apart.
3. Insert the two anchors and mounting screws supplied in the marked locations on the wall, leaving a space of about 1/4 inch (6 mm) between the wall and screw head.

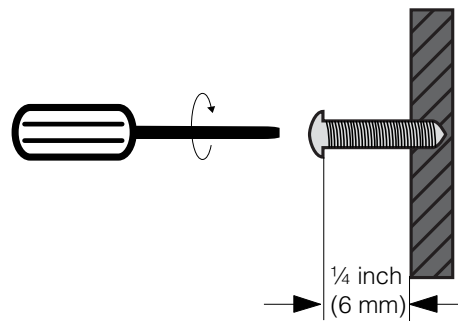

If you are mounting the Conext ComBox on concrete, the supplied anchors and mounting screws are not suitable. Use two mounting screws that are equivalent to #6 screws.

4. Place the Conext ComBox on the mounting screws, and confirm a snug fit before going to the next step.

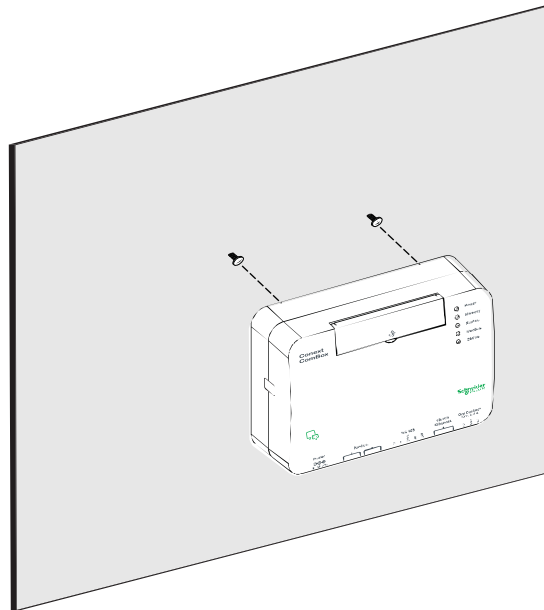

5. Connect the wiring and cables. Go to “Wiring the RS 485 Modbus Connector for Power to the Conext ComBox” on page 2–14.

DIN Rail Mount

A standard 35-mm “top hat” DIN rail (EN50022) must be used for mounting.

To mount the Conext ComBox on the DIN Rail:

1. Choose the location for mounting the device.
2. Using heavy duty scissors or a diagonal cutter, cut both ends of the side tab on one end of the Conext ComBox.

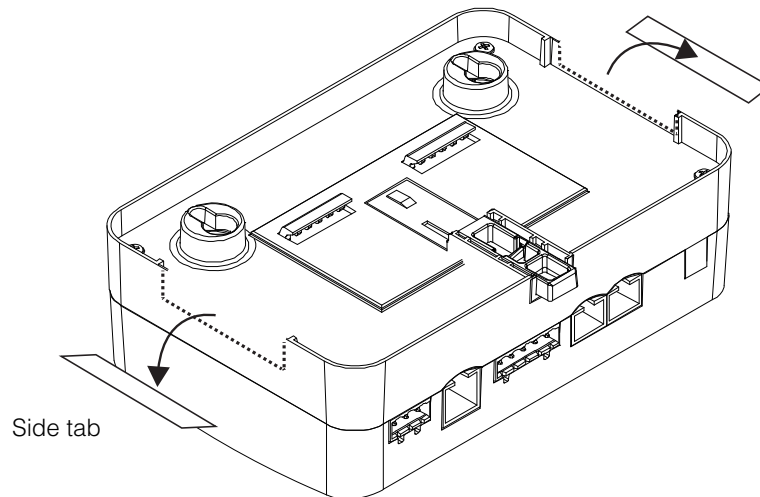

3. Break off the side tab. You may need to use pliers for this.
4. Repeat steps 2 and 3 for the tab at the other end of the Conext ComBox.
5. Use a suitable tool, such as a screwdriver, to pull down the catch on the bottom of the Conext ComBox.
6. Mount the Conext ComBox on the DIN rail and release the catch. See the following illustration.

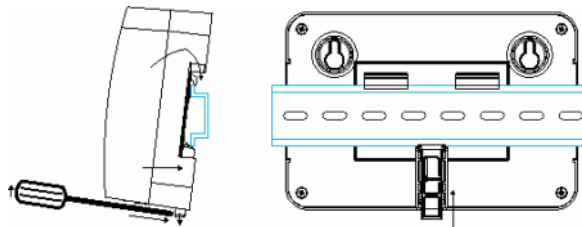

DIN rail catch

7. Connect the wiring and cables.

Wiring the RS 485 Modbus Connector for Data Communication to the Conext ComBox

The RS 485 Modbus connector provides three terminals to wire communication cables to the Conext ComBox. The five-terminal RS 485 connector uses the first three terminals for a data cable. The cable has a size of 16–24 AWG with 1.5 mm^2 – 0.25 mm^2 wires. The cable can be shielded or non-shielded.

To wire the RS 485 Modbus connector for data communication:

1. Select a two-wire, twisted pair, shielded cable not longer than 164 feet (50 m). Refer to the local electrical code and application to select the insulation and temperature class of the cable to be used.
2. Strip $3/8$ in. (10 mm) from the end of the wires to be connected and attach ferrules to the two signal wires (red and black in the following diagram).
3. Insert the ferrules and the shield wire into the connector terminals as shown in the following diagram.

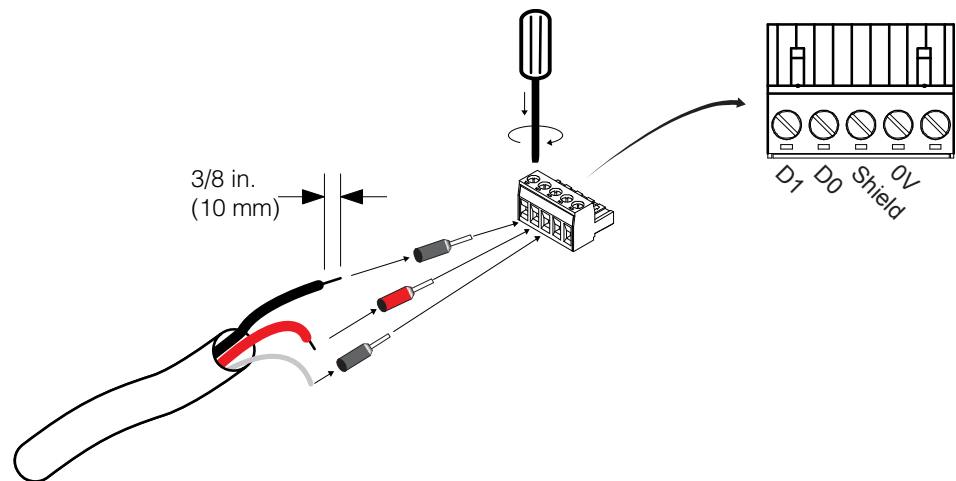

4. Secure the wires by tightening the screw on the terminal.
The middle terminal is not connected internally but is provided for the shield connection of the cable.
5. If you intend to use the Dry Contact, go to “Wiring the Dry Contact Connector”. Otherwise, go to “Connecting the Conext ComBox to an Ethernet Network”.

Modbus versus Xanbus

The RS 485 Modbus connection and Xanbus cable connection provide data communication from the network and devices to the Conext ComBox. Communication with Modbus devices is handled through the RS 485 or 10/100 Ethernet connection on the Conext ComBox while communication with Xanbus components occurs through the Xanbus ports of Xanbus-enabled devices.

Connecting the Conext ComBox with other Modbus Devices

In a Modbus implementation, the Conext ComBox can act as a master or slave to an RS 485 master device. The RS 485 connection to the Conext ComBox allows communication between the Xanbus network and the third- party device. This enables Conext devices to link to third-party software and building management systems.

If a Modbus device, including the Conext ComBox, is installed as the last device in a daisy chain, a 120 ohm terminator must be used because they do not have an internal terminator for the RS 485 network. When inserting two wires in one terminal, as in the case of daisy-chained RS 485 Modbus devices, use smaller gauge wires. See the following example.

Note: Turn off all Modbus and other devices prior to wiring the connectors.

Note: A common ground line (0V) between all Modbus devices is also required.

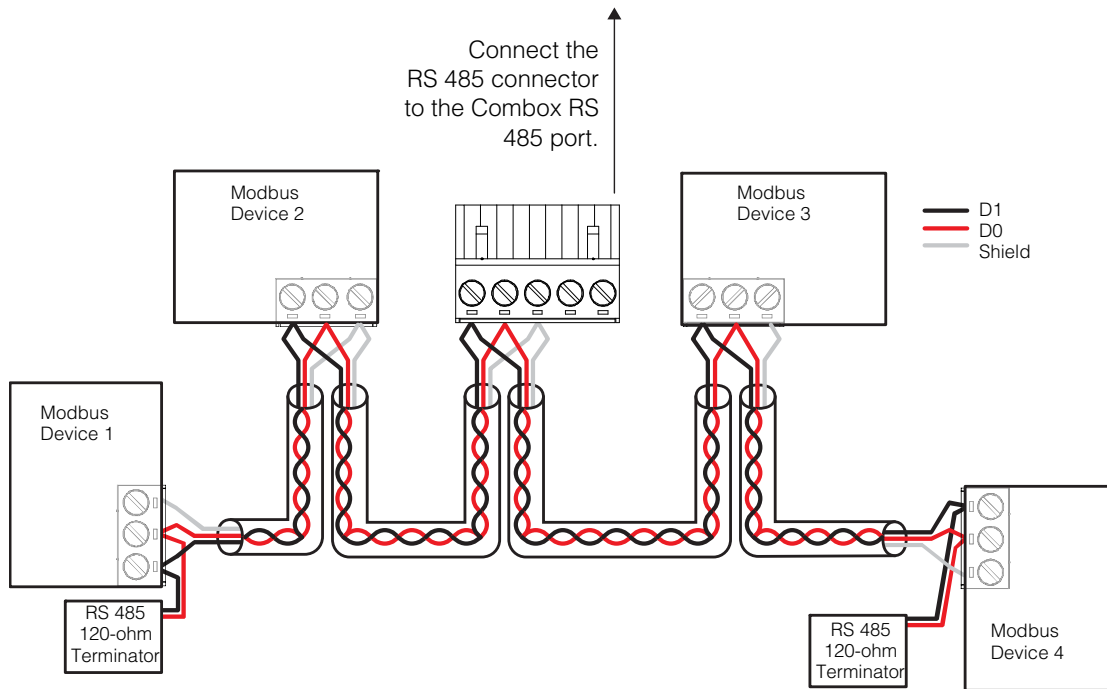

Wiring the Dry Contact Connector

Wiring instructions for dry contact wiring for SELV devices is included in this section. The dry contact connector is intended to control the trigger of SELV devices such as small DC fans or external AC or DC relays. It does not provide power to the Conext ComBox.

To wire the dry contact connector:

⚡ ⚡ DANGER

ELECTRIC SHOCK AND FIRE HAZARD

- Turn off all other devices prior to wiring the connectors.
- The Dry contact port must only be connected to a circuit rated 24V DC max, 4A max, and supplied from an SELV source.

Failure to follow these instructions will result in death or serious injury.

1. Strip 3/8 in. (10 mm) from the end of the wire to be connected and attach ferrules to the bare wires.
2. Insert the ferrule into the Dry Contact connector's wire terminal.
3. Secure the wire by tightening the screw on the terminal.

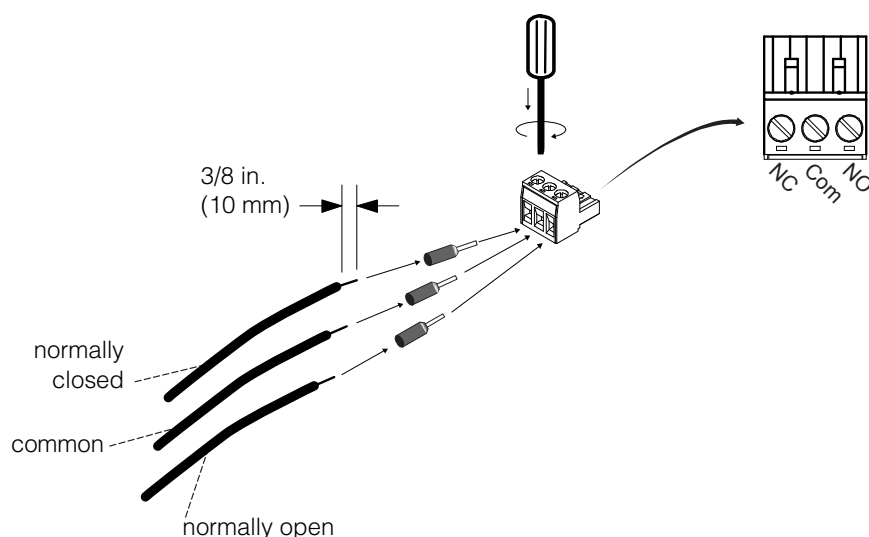

4. Repeat steps 2 and 3 for the remaining wires.

Note: The Dry Contact Connector should not be used for any safety-critical applications.

5. Once all the Dry Contact wires are secured, push the Dry Contact connector into the Dry Contact port until it locks into place.
6. Go to "Connecting the Conext ComBox to an Ethernet Network".

Connecting the Conext ComBox to an Ethernet Network

Note: The computer and network router may remain powered at this stage in the process. If not already powered, make sure these two devices are on before proceeding.

Before connecting a computer and router to the Conext ComBox, make sure it meets the following prerequisites.

Router

The network router must be able to supply DHCP addresses automatically to connected devices. If your network router does not support automatic DHCP, refer to your network router's user guide or contact your system administrator.

Operating System

- Microsoft® Windows® 7 (recommended) or later
- Windows Vista® X86
- Mac OS® X 10.4.8. or later

Web Browsers

- Mozilla® Firefox® 12.x or later
- Microsoft® Windows® Internet Explorer® 10.x or later
- Google Chrome™ 34.x or later
- Safari® 5.x or later

Note: JavaScript and cookies must be enabled in your web browser.

To connect the Conext ComBox to a Computer on an Ethernet Network:

1. Make sure the computer and network router are turned on and the Conext ComBox is not turned on. Make sure the network router selected has DHCP enabled.
2. Connect one end of an Ethernet cable to the computer's network port.

<i>NOTICE</i>
EQUIPMENT DAMAGE <ul style="list-style-type: none">• Do not connect an Ethernet cable from the Conext ComBox to the WAN/MODEM port on the network router.• Do not connect an Ethernet cable plug into a Xanbus port on the Conext ComBox. <p>Failure to follow these instructions can damage equipment.</p>

3. Connect the other end of the Ethernet cable to a vacant Ethernet/LAN port on the network router.

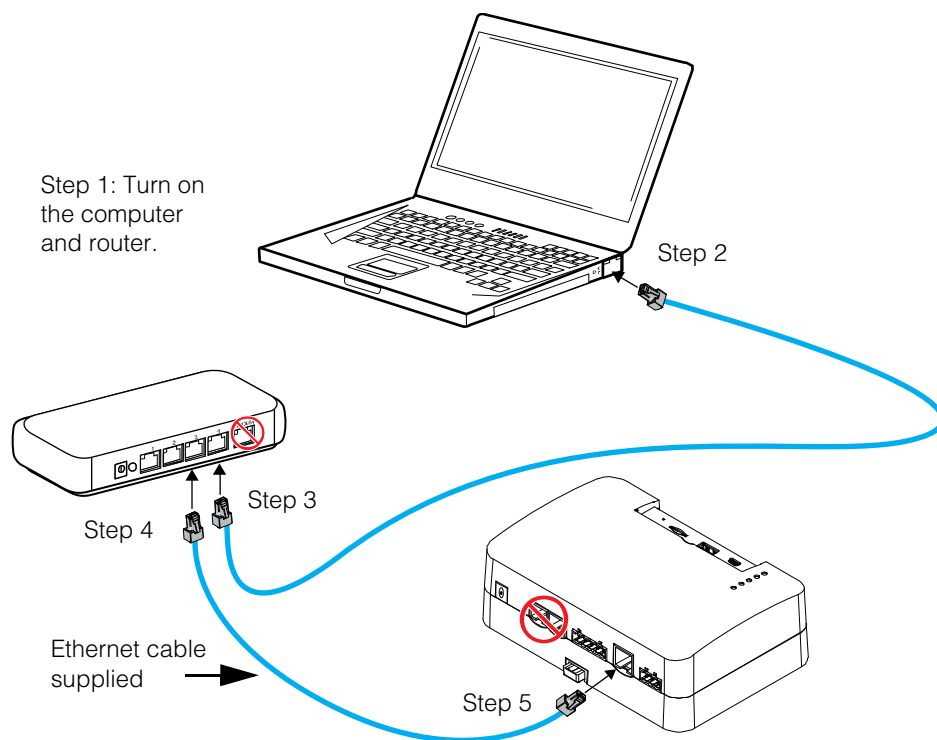

4. Connect one end of the Ethernet cable (supplied) to the LAN port on the network router.
At this stage, the network router should be on but the LED showing port activity on the router will not show any indication.
5. Connect the other end of the Ethernet cable to the Conext ComBox.
At this stage the Ethernet cable should be the only cable (except for the Dry Contact if used) plugged into the Conext ComBox.

Turning On the Conext ComBox

The Conext ComBox must be wired into an Ethernet connection before it is powered up. Follow the sequence of steps in “Connecting the Conext ComBox to an Ethernet Network” on page 2–10.

To turn on the Conext ComBox:

1. Connect a power source to the Conext ComBox. You can do either of the following:
 - Plug the AC/DC power adapter into the AC wall outlet (see “Connecting the AC/DC Power Adapter”), or
 - Plug the RS 485 connector, which has been wired with a 24 V DC power supply, to the RS 485 port on the Conext ComBox until it locks into place. See “Wiring the RS 485 Modbus Connector for Power to the Conext ComBox” for the wiring procedure.

⚠ WARNING
PHYSICAL INJURY HAZARD Xanbus is a valid power source for the Conext ComBox. However, for the first time set-up, using Xanbus as a power source is not recommended. the Conext ComBox clock will override the other Xanbus devices' clocks and could trigger unintentional time-based events. Therefore, DO NOT connect the Conext ComBox to the Xanbus network prior to setting up the internal clock of the Conext ComBox. Refer to “Changing the Time” on page 3–6. If Xanbus is the only source powering the ComBox, after installation verify the time settings in all devices. Failure to follow these instructions can result in death or serious injury.

2. When power is applied to the Conext ComBox, all the LEDs flash once and then the Power LED flashes intermittently for approximately two minutes during the application loading and initialization sequence.
Wait until the Power LED lights up steadily before proceeding to the next step. See “LED Indicator Lights (LEDs)” on page 1–4.
3. When the Conext ComBox is ready, proceed to either “Finding the Conext ComBox on the Network” on page 2–16 or “Logging in to the Conext ComBox Web User Interface Using a USB Thumb Drive” on page 2–17.

Connecting the AC/DC Power Adapter

⚡ ⚠ DANGER

ELECTRIC SHOCK AND FIRE HAZARD

Use only the AC/DC Power Adapter supplied with this Conext ComBox unit. When ordering a replacement, reference PN: 0J-921-0023-Z.

Failure to follow these instructions will result in death or serious injury.

To use the AC/DC power adapter supplied with the Conext ComBox as a power source:

1. Conext ComBox uses a universal plug with interchangeable pins and plug styles.

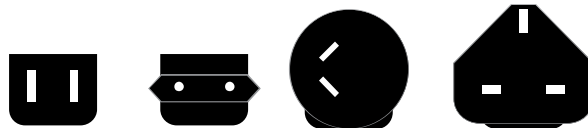

2. Connect the power plug to the AC outlet.
3. Connect the other plug of AC/DC power adapter to the Power port on the Conext ComBox.
4. Go to step 2 of “Turning On the Conext ComBox”.

Wiring the RS 485 Modbus Connector for Power to the Conext ComBox

To use the Modbus RS 485 connector to provide power to the Conext ComBox, use the following procedure. When powering the Conext ComBox through the 24 V DC terminals on the RS 485 connector, use a power supply (AC/DC or DC/DC) that provides galvanic isolation to meet the required SELV connections.

⚠ ⚠ DANGER

ELECTRIC SHOCK AND FIRE HAZARD

If the power terminals on the Modbus RS 485 connector are used, the RS 485 connector must only be connected to a circuit rated 24V DC max, 1A max (fused on the positive wire), and supplied from an SELV source.

Failure to follow these instructions will result in death or serious injury.

NOTICE

EQUIPMENT DAMAGE

Turn OFF all devices before connecting cables. The Conext ComBox does not have an ON/OFF switch. See “Power Cycle” below.

Failure to follow these instructions can damage equipment or affect performance.

Power Cycle

To power cycle the Conext ComBox:

1. Turn the Conext ComBox OFF – perform a proper shutdown (see “Shutting down the Conext ComBox” on page 3–14) then unplug and disconnect it from all power sources.
2. Wait ten seconds before the next step.
Ensure that there is no USB thumb drive inserted in the USB Host port.
3. Turn the Conext ComBox ON – plug and connect it to a power source.

Wiring Steps

To wire the RS 485 Modbus connector for power to the Conext ComBox:

1. Turn off the 24 V DC power supply, if not already.
2. Unplug the RS 485 connector from the RS 485 port on the Conext ComBox.
3. Strip 3/8 in. (10 mm) from the end of the 0 V (–) wire of the power cable.
4. Terminate the wire with a ferrule.
5. Install a 1A DC fuse on the 24 V (+) wire of the power cable and strip 3/8 in. (10 mm) from the end of the wire.
6. Terminate the wire with a ferrule.

7. Insert the ferrules into the Modbus connector's wire terminals as shown.

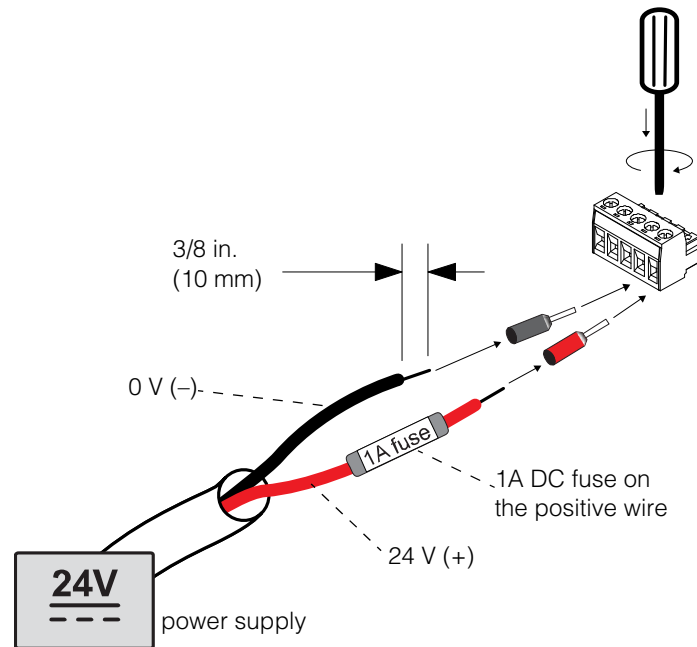

Note: The polarity of the wires is shown above and on the unit.

8. Secure the wires by tightening the screws on the terminal.
9. Plug the Modbus connector into the RS 485 port of the Conext ComBox.
10. Turn on the 24 V DC power supply.
11. Go to step 2 of "Turning On the Conext ComBox".

Finding the Conext ComBox on the Network

After the Conext ComBox is wired into and powered up on a LAN, it will exist as a LAN device at an IP address. The following procedure describes how to find the Conext ComBox LAN address.

To find the Conext ComBox on your network:

1. Load the Conext ComBox CD (supplied) in the computer.
If the computer in the Conext ComBox system does not have a CD drive:
 - On a computer with an optical drive, copy the Device Discovery Tool folder on the CD to a USB thumb drive.
2. Temporarily disable all antivirus software including firewall protection software running in the background.
3. Open the **Device Discovery Tool** folder either on the Conext ComBox CD or the USB thumb drive.
4. Double-click **ConextComBoxLocator.jar**.

This tool requires Java Runtime Environment (JRE). If you see a message about this, go to <http://www.java.com/en/download/index.jsp> to download and install JRE.

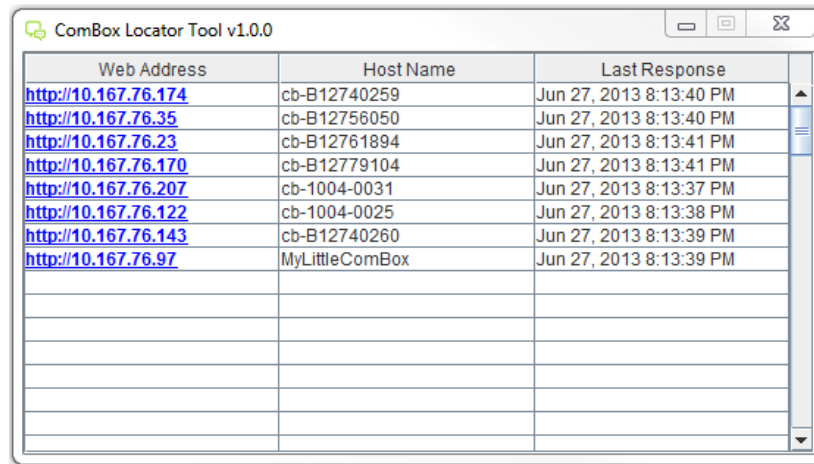

Web Address	Host Name	Last Response
http://10.167.76.174	cb-B12740259	Jun 27, 2013 8:13:40 PM
http://10.167.76.35	cb-B12756050	Jun 27, 2013 8:13:40 PM
http://10.167.76.23	cb-B12761894	Jun 27, 2013 8:13:41 PM
http://10.167.76.170	cb-B12779104	Jun 27, 2013 8:13:41 PM
http://10.167.76.207	cb-1004-0031	Jun 27, 2013 8:13:37 PM
http://10.167.76.122	cb-1004-0025	Jun 27, 2013 8:13:38 PM
http://10.167.76.143	cb-B12740260	Jun 27, 2013 8:13:39 PM
http://10.167.76.97	MyLittleComBox	Jun 27, 2013 8:13:39 PM

5. In the list that appears, click the **Web Address** for the Conext ComBox (cb-XXXX where XXXX is a factory- assigned number).

If a web browser opens up, you will see the Conext ComBox user interface **Login** window. Go to the next step.

The default value of the **Web Server Port** is **80**. For example, if you change this value to **8080**, you must append the URL address with **":8080"** at the end of the IP address (e.g. <http://10.167.73.66:8080>).

If a web browser window does not open:

- Note the **Web Address** for the Conext ComBox.

- Open a web browser.
- Enter the Conext ComBox **Web Address** in the **URL** field.
- Press Enter on the keyboard.
The Conext ComBox user interface **Login** window appears.

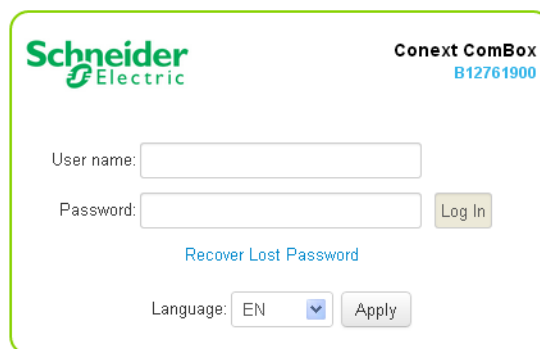

The screenshot shows the login page for the Conext ComBox. At the top left is the Schneider Electric logo. At the top right, it says 'Conext ComBox B12761900'. Below this are two input fields: 'User name:' and 'Password:'. To the right of the password field is a 'Log In' button. Below the password field is a blue link that says 'Recover Lost Password'. At the bottom, there is a 'Language:' dropdown menu currently set to 'EN' and an 'Apply' button next to it.

6. Enable all antivirus software including firewall protection software.
7. To complete configuration of your Conext ComBox, go to the “Configuration” section.

Logging in to the Conext ComBox Web User Interface Using a USB Thumb Drive

In cases where it is not practical to obtain the Conext ComBox's IP address using the Device Discovery tool (or using the Windows network browser), obtain the IP address using a USB thumb drive.

1. Plug a USB thumb drive into the Conext ComBox's USB Host data port while the Conext ComBox unit is powered on (the Power LED is steadily on and not flashing).
2. Watch the Memory LED and wait for it to flash quickly five times.
3. Remove the USB thumb drive from the USB Host data port.
4. Plug the USB thumb drive into your computer's USB port.
5. Use the file system browser on your computer to navigate to the thumb drive's root directory.
6. Look for a file named *serial number.html*, where *serial number* is the Serial Number of the Conext ComBox.
7. Double-click the *serial number.html* file. Your default web browser will launch and display the System Information below.

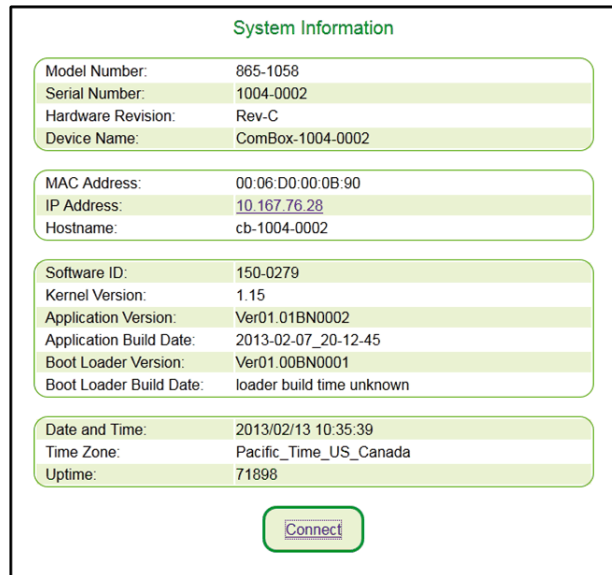

8. Click the Connect button shown within System Information. The web browser opens up and the Conext ComBox user interface **Login** window appears. Note that this will only work if your computer is on the same Local Area Network as the Conext ComBox.

3

Configuration

Chapter 3 describes how to configure settings for the Conext ComBox. It also includes how to connect devices to the Xanbus network. The topics are:

- Configuration Steps
- Logging In
- Changing the Admin Password
- Changing the Time
- Changing E-Mail Settings
- Connecting the Conext ComBox to the Xanbus Network
- Changing Conext ComBox Settings
- Modbus Master Configuration
- Resetting the Conext ComBox to Factory Settings
- Changing Device Settings
- Upgrading Firmware
- Conext ComBox Master-Slave Configuration

Configuration Steps

To complete Conext ComBox setup, you must successfully complete the procedures in the Installation section. Make sure the Conext ComBox is connected, the **Power** LED is on, and the **Status** LED is off. Your Xanbus devices should still be in standby mode.

When you log in to the web user interface, most of the setup information appears automatically with their default values. Some information requires change (such as passwords), some information can be modified as needed, and some information can only be modified by a qualified IT professional.

The following items are part of the Conext ComBox configuration process:

Primary

- Log in - see "Logging In"
- Change the password - see "Changing the Admin Password"
- Set the time - see "Changing the Time"
- Enter e-mail information - see "Changing E-Mail Settings" and sending reports - see "E-mail Reporting"
- Connect the Conext ComBox to the Xanbus network - see "Connecting the Conext ComBox to the Xanbus Network"

Secondary

- Change TCP/IP settings if you want to use static IP addresses - see "TCP/IP Settings"
- Configure Conext ComBox settings - see "Changing Conext ComBox Settings"

Optional/ Occasional

- Configure general device settings - see "Changing Device Settings"
- Clear the device memory - see "Clearing Conext ComBox Internal Firmware Memory"
- Upgrade the device firmware - see "Upgrading Firmware"

Logging In

The first time you log in to the Conext ComBox web user interface, use the default **User name:** *admin* and **Password:** *password*.

NOTE: See “Two Types of Accounts” below.

Two Types of Accounts

User name	Password	Privileges
<i>admin</i>	<i>password</i>	System-level access. Allows read and write access to settings on the Conext ComBox as well as Xanbus devices. Allows system and status monitoring including logging.
<i>user</i>	<i>user</i>	Limited access. Allows only read access to devices, system monitoring, and status monitoring.

The Warning and Disclaimer page appears. Click the checkbox next to “I agree...” then click “I understand and accept”.

Schneider Electric **Conext ComBox**
B12740259

⚠ WARNING

HAZARD OF PHYSICAL INJURY AND UNEXPECTED OPERATION

Refer to the owner's guide for more detailed information when making any changes to settings or sending commands. Commands sent to this device may affect other components in the system. Ensure that anyone working with the system is aware of the result of your changes before sending a command.

Failure to follow these instructions can result in death or serious injury

Your ComBox includes an internet-based remote monitoring feature or service (the "Remote Monitoring Service") which will automatically transmit data about your system equipment, its performance and other variables (the "System Data") over the internet to Schneider Electric's computer storage facilities as soon as the ComBox is connected to the internet if you enable the Remote Monitoring Service by checking the box below acknowledging your acceptance of these terms and then clicking the "I Understand and Accept" button below. The Remote Monitoring Service provides you access to your System Data via the internet. You have the option to either enable at a later date or disable remote monitoring on the ComBox at any time. Please contact Schneider Electric if you have any questions. Schneider Electric reserves the right to store and retain the System Data indefinitely and the right to use the System Data for any purpose including (but not limited to) quality assurance, engineering performance and product improvements. By enabling the Remote Monitoring Service, you consent to this automatic transmission and Schneider Electric's storage and use of the System Data. **Schneider Electric provides the Remote Monitoring Service (including your access to the System Data) without any warranty or representation whatsoever as to its sufficiency, accuracy, availability or reliability and assumes no responsibility or liability from your use of the Remote Monitoring Service.**

I agree with the above and the Remote Monitoring Service



I Understand and Accept

Figure 3-1 Warning and Disclaimer

Changing the Admin Password

Change the password from the default “password” as soon as you log in to the ComBox.

To change the Conext ComBox Admin Password:

1. In the menu tree, click the arrow to the left of  ComBox Configuration to expand the menu.
2. The Configuration menu appears. Click  Settings in the menu bar to change the password.
3. Under **Conext ComBox Settings**, click **Change Admin Password**.

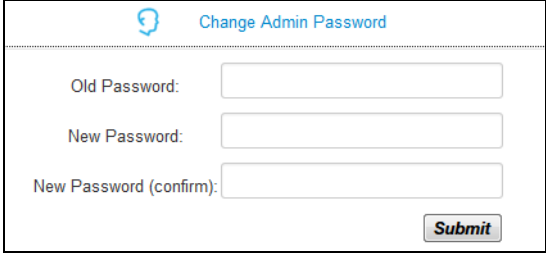

The screenshot shows a web form titled "Change Admin Password". It contains three text input fields labeled "Old Password:", "New Password:", and "New Password (confirm):". A "Submit" button is positioned at the bottom right of the form area.

4. Enter the **Old Password**.
5. Enter your **New Password**.
The password should contain at least eight alphanumeric (0-9, a-z, A-Z) characters with no special characters and spaces. Passwords are case-sensitive, and the maximum length is 32 characters.
6. Enter the **New Password (confirm)** again.
7. Click **Submit**.
A message indicates that the password change was successful.

Changing the Time

⚠ WARNING

PHYSICAL INJURY HAZARD



Be careful when changing the Conext ComBox time setting. It will override any time settings on individual Xanbus-enabled devices in the network. The time represents the entire system. Any appliance or equipment that is time-controlled by a Xanbus device, such as a generator connected to an AGS, can inadvertently turn on at the wrong time.

Failure to follow these instructions can result in death or serious injury.

You can also choose to use the network time for your system. If enabled, network time (SNTP) will override the Conext ComBox Time setting at the next SNTP polling update. See “Using Network Time”.

The default setting has SNTP network time enabled (SNTP state is On).

To change the Conext ComBox time and/or date:

1. In the menu bar, click the arrow to the left of  ComBox Configuration to expand the menu.
2. The Configuration menu appears. Click  **Settings** in the menu bar.
3. Under **Conext ComBox settings**, click **Time and Zone**.

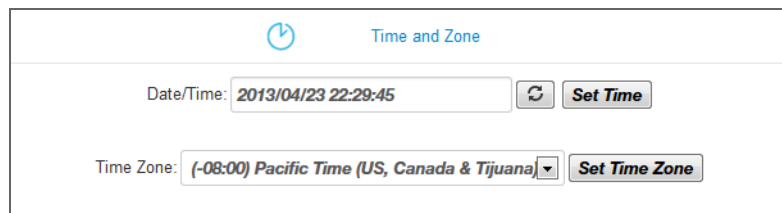

4. Click  to display the current time.
5. To change the Date/Time, enter it in the same format as shown (YYYY/MM/DD HH:MM:SS) and click **Set Time**.
6. To set the Time Zone, select from the drop-down list and click **Set Time Zone**.







Note: This date/time setting overrides settings on other devices in the system.

Using Network Time

You can choose to use the network time for your Conext ComBox system.

Note: If you enable this option, it will replace any manual settings you set under Time and Zone at the next update according to the SNTP poll setting.

To use the network time and date:

1. In the menu bar, click the arrow to the left of  ComBox Configuration to expand the menu.
2. The Configuration menu appears. Click  **Settings** in the menu bar.
3. Under **Conext ComBox settings**, click **Network Time (SNTP)**.
4. In **SNTP Server Name**, enter the IP address or URL of the network time server, (**pool.ntp.org** is recommended) and then click .
5. In **SNTP Poll Interval**, enter (in hours) how often you want to update the Conext ComBox system time to the network time and then click .
6. To enable the automatic network time setting, select **SNTP State On** and then click .
To disable the automatic network time setting, select **SNTP State Off** and then click .
7. To perform a manual network time synchronization (SNTP State must be On), click  under **Perform SNTP Synchronization**.

Changing E-Mail Settings

E-Mail Settings

Parameter	Value	
Mailer Status	<input type="text" value="Enabled"/>	<input type="button" value="↺"/> <input type="button" value="💾"/>
E-Mail Server Address	<input type="text" value="mailserver.yourdomain.com"/>	<input type="button" value="↺"/> <input type="button" value="💾"/>
E-Mail Server Port	<input type="text" value="25"/>	<input type="button" value="↺"/> <input type="button" value="💾"/>
E-Mail Recipients	<input type="text"/>	<input type="button" value="↺"/> <input type="button" value="💾"/>
E-Mail Authentication	<input type="text" value="Disabled"/>	<input type="button" value="↺"/> <input type="button" value="💾"/>
E-Mail User ID	<input type="text" value="user@yourdomain.com"/>	<input type="button" value="↺"/> <input type="button" value="💾"/>
E-Mail Password	<input type="text"/> (New) <input type="text"/> (Confirm)	<input type="button" value="↺"/> <input type="button" value="💾"/>
Lost Password E-Mail Recipients	<input type="text"/>	<input type="button" value="↺"/> <input type="button" value="💾"/>
Lost Password E-Mail From Address	<input type="text" value="no-reply@schneider-electric.com"/>	<input type="button" value="↺"/> <input type="button" value="💾"/>
Reset Lost Passwords	<input type="text" value="No"/>	<input type="button" value="↺"/> <input type="button" value="💾"/>
Send Test E-mail	<input type="button" value="Send"/>	

Mailer Status

Activate or deactivate e-mailing features. When enabled, a user who forgets a password when trying to log in can have the Conext ComBox send the current password or a randomly generated temporary password by e-mail.

E-mail Server Address

Specify the mail server address provided by the Internet service provider. It has the format *mailserver.yourdomain.com*. Contact your Internet service provider for the correct information.

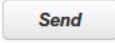
E-mail Server Port	Specify the port number used by a computer to transmit electronic data through the Internet. The number 25 is typically reserved for e-mail.
E-mail Recipients	Enter multiple e-mail addresses separated by a comma and no space. Any address listed here will receive e-mail messages generated by the Conext ComBox.
E-mail Authentication	Enable or disable an external e-mail's authentication settings. When enabled, you have to supply the E-mail User ID and E-mail Password below.
E-mail User ID	Specify the external e-mail account's user ID, which is usually the full e-mail address that includes the domain name.
E-mail Password	Specify the external e-mail account's password.
Lost Password E-Mail Recipients	Specify a valid e-mail address where the current password or a random temporary password can be sent. For multiple e-mail recipients, separate the addresses with a comma and no space.
Lost Password E-Mail From Address	Specify a valid e-mail address that can be used as an identifier of the sender. Generally, the sender is also the user of the Conext ComBox. By default, this is set to <i>no-reply@schneider-electric.com</i> and should not be changed.
Reset Lost Passwords	Select No to send the current password by e-mail. Select Yes to generate a random temporary password to be sent by e-mail.
Send Test E-Mail	Test that the e-mail settings above have been configured correctly. Press the  button to send a sample e-mail message to the addresses listed in the E-mail Recipients parameter. Mailer Status must be enabled for the button to work.

Connecting the Conext ComBox to the Xanbus Network

After you have installed and configured the Conext ComBox, you can add the Xanbus devices. The Conext ComBox application automatically discovers new devices, and Modbus addresses are assigned according to the starting address configuration settings. Log out of the web user interface and then log in again to check the Modbus address for the new device and its status.

The Xanbus network cable (a CAT5 cable) can provide both data communication and power from Xanbus-enabled devices.

When applying power to the Conext ComBox by connecting it to the Xanbus network, make sure the Xanbus network itself has power. The inverter/charger or controller supplying power to the Xanbus network must be operating.

The following Xanbus-enabled devices can provide power to the Xanbus network:

- Conext XW+ Inverter/Chargers
- Conext SW Inverter/Chargers
- MPPT 80 600 Solar Charge Controllers

The MPPT 60 150 Solar Charge Controller, Conext System Control Panel, and Conext Automatic Generator Start cannot provide power to the Conext ComBox. However, two or more Conext TX Grid-tie Inverters in the same Xanbus network can supply enough power to the Conext ComBox.

Note:

- Use Xanbus network cables that are at least 6.5 feet (2 m) long such as:
 - 25-foot (7.6-m) network cable (809-0940)
 - 75-foot (22.9-m) network cable (809-0942)
- Using Xanbus network cables shorter than 6.5 feet (2 m) will result in degraded Xanbus network performance

Note:

- Xanbus components can be arranged in any order^a.
- Use a network terminator at both ends of the Xanbus network.

a. Similar to the Grid-Tie Solar Inverter Monitor, a maximum of five Grid-Tie inverters can be connected in series to the Conext ComBox. Since the Conext ComBox can support up to 20 Grid-Tie inverters, you can use a hub to connect four sets of 5 Grid-Tie inverters.

Note: Xanbus is a valid power source for the Conext ComBox. However, for first-time setup, using Xanbus as a power source is not recommended. The Conext ComBox clock will override the other Xanbus devices' clocks and could trigger unintentional time-based events. Therefore, DO NOT connect the Conext ComBox to the Xanbus network prior to setting up the internal clock of the Conext ComBox. If Xanbus is the only power source to the ComBox, after installation verify the time settings in all devices. See "Changing the Time" on page 3-6.

To connect the Conext ComBox to a Xanbus network:

The assumption at this point is that there is an existing Xanbus network and all Xanbus-enabled devices in that network have been previously interconnected with each other.

1. Put the Xanbus-enabled inverters, inverter/chargers, and solar charge controllers into standby mode before connecting the Conext ComBox to avoid triggering any unintentional time-based events.

You may put the Xanbus-enabled inverters, inverter/chargers, and solar charge controllers out of standby mode later when you have completed configuration of the Conext ComBox.

2. Using the sample illustration below, connect the Conext ComBox to the Xanbus network.

<i>NOTICE</i>
EQUIPMENT DAMAGE Do not connect a Xanbus RJ-45 cable plug into the 10/100 Ethernet port of the Conext ComBox. Failure to follow these instructions can damage equipment or affect network performance.

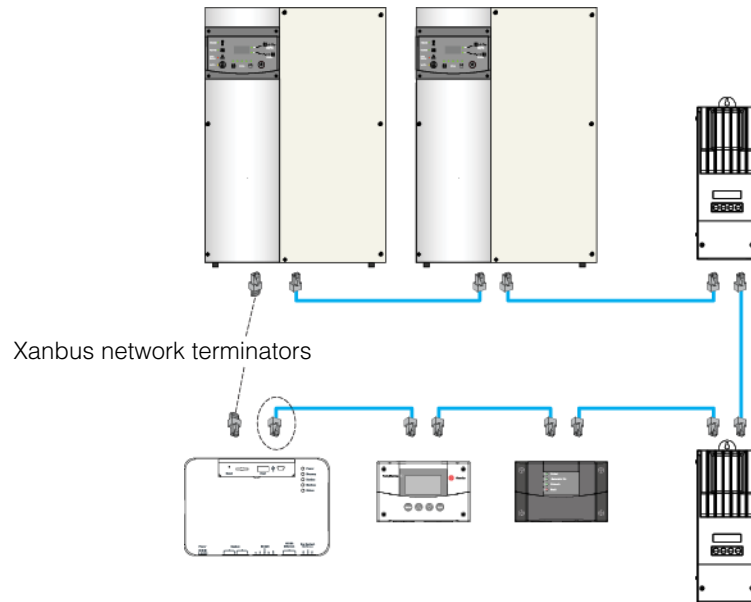

Be sure to terminate the Xanbus network with Xanbus network terminators at both ends.



When the Conext ComBox starts communicating with other Xanbus-enabled devices on the network, the Xanbus LED will go on.

The Conext ComBox is now ready to configure, control, and monitor the devices connected on the Xanbus network.



Changing Conext ComBox Settings

The procedures for configuring the other Conext ComBox Settings are described in the following sections.

To change Conext ComBox Settings:

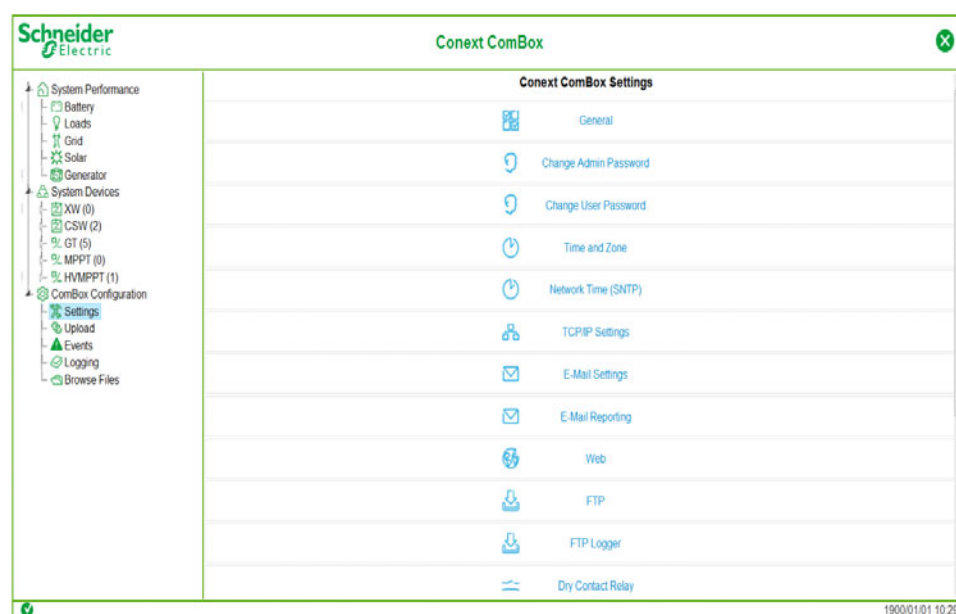
1. In the menu bar, click the arrow to the left of  ComBox Configuration to expand the menu.
2. The Configuration menu appears. Click  **Settings** in the menu bar.
3. You will see a screen similar to the one shown below.



4. Click the setting type you want to change.
That portion of the window expands to display the change options for that setting. The size and content of the expanded window varies depending on the setting type.
5. In the expanded window, click  to see the current setting. This may be different from the value shown if the change was made in another way.
6. Modify the value(s) as necessary.
7. Click  to save the change(s).



General Settings

Parameter	Value
Device Friendly Name	<input type="text" value="B12345678"/>  
Reboot Conext ComBox	<input type="button" value="Reboot"/>
Shutdown Conext ComBox	<input type="button" value="Shutdown"/>

Changing the device name

The default **Device Friendly Name** is the device’s serial number assigned at the factory. It is good practice to change this default to a user-friendly name.

To change the device name:

1. Replace the default value using alphanumeric characters.
2. Click  to save the setting.
3. To recall the previous value, click .

Rebooting the Conext ComBox

You can reboot the Conext ComBox unit from the web user interface without doing a power cycle. This type of “soft” rebooting is oftentimes necessary when certain settings are changed, like changing the Xanbus Bit Rate parameter.

To reboot the Conext ComBox:

1. Click the button. A Warning dialog box appears.
2. Click the OK button on the Warning dialog box.
3. To discontinue rebooting, click the Cancel button on the Warning dialog box.

Shutting down the Conext ComBox

You should shut down the Conext ComBox unit from the web user interface. Shutting down is equivalent to turning off the unit, usually for preparing to store the unit away or to reinstall the unit at a different location.

Note: Do not shut down by abruptly disconnecting all power sources to the Conext ComBox without following the procedure below. An abrupt disconnection may result in data corruption.

To shut down the Conext ComBox:

1. Click the button. A Warning dialog box appears.
2. Click the OK button on the Warning dialog box.
3. To discontinue shutting down, click the Cancel button on the Warning dialog box.

Change User Password Settings

The Change User Password setting applies only to the Conext ComBox user account.

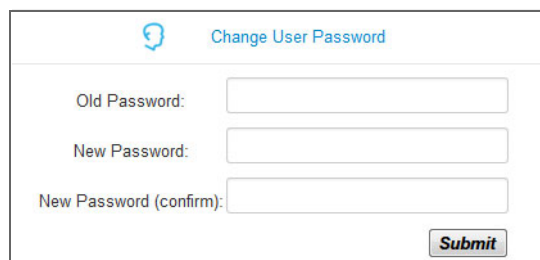
A screenshot of a web form titled "Change User Password". The form has a header with a blue user icon and the text "Change User Password". Below the header, there are three input fields: "Old Password:", "New Password:", and "New Password (confirm):". Each field is a simple rectangular box. At the bottom right of the form is a button labeled "Submit".













1. Enter the **Old Password**.
2. Enter your **New Password**.
The password should contain at least eight alphanumeric (0-9, a-z, A-Z) characters with no special characters and spaces. Passwords are case-sensitive and the maximum length is 32 characters.
3. Enter the **New Password (confirm)** again.
4. Click **Submit**.
A message indicates that the password change was successful.

Change Admin Password Settings

The Change Admin Password setting applies only to the Conext ComBox admin account.

See "Changing the Admin Password" on page 3–5.

TCP/IP Settings

 TCP/IP Settings	
Parameter	Value
TCP/IP Address	<input type="text" value="10.167.76.67"/>  
TCP/IP Net Mask	<input type="text" value="255.255.255.0"/>  
Gateway Address	<input type="text" value="10.167.76.1"/>  
DNS Server Address	<input type="text" value="10.167.77.80"/>  
Device Name	<input type="text" value="cb-1004-0035"/>  
Use DHCP	<input type="text" value="Yes"/>  

By default, the Use DHCP parameter is set to Yes. By enabling DHCP, the four parameters (TCP/IP Address, TCP/IP Net Mask, Gateway Address, and DNS Server Address) are filled automatically. If the Use DHCP parameter is set to No, you have to manually fill the four parameters with static IP addresses.

Note: Only a qualified IT professional should perform changes to any TCP/IP related settings.

E-mail Settings

See “Changing E-Mail Settings” on page 3–8.

E-mail Reporting

 E-Mail Reporting	
Parameter	Value
Email System Report	No <input type="button" value="↺"/> <input type="button" value="💾"/>
System Report: Generator Energy	Included <input type="button" value="↺"/> <input type="button" value="💾"/>
System Report: Load Energy	Included <input type="button" value="↺"/> <input type="button" value="💾"/>
System Report: Sold To Grid	Included <input type="button" value="↺"/> <input type="button" value="💾"/>
System Report: Used From Grid	Included <input type="button" value="↺"/> <input type="button" value="💾"/>
System Report: PV Harvest	Included <input type="button" value="↺"/> <input type="button" value="💾"/>
System Report: Used From Battery	Not Included <input type="button" value="↺"/> <input type="button" value="💾"/>
System Report: Stored In Battery	Not Included <input type="button" value="↺"/> <input type="button" value="💾"/>
Email Device Report	No <input type="button" value="↺"/> <input type="button" value="💾"/>
Email Report Frequency	Daily Report <input type="button" value="↺"/> <input type="button" value="💾"/>
Email Report Day (For Weekly Mail)	Sunday <input type="button" value="↺"/> <input type="button" value="💾"/>
Email Report Day (For Monthly Mail)	Last Day of the Month <input type="button" value="↺"/> <input type="button" value="💾"/>
Send Test Report	<input type="button" value="Send"/>

Email System Report





Activate or deactivate system reporting features. When activated (Yes), system reports are sent electronically to recipients listed in **E-Mail Recipients** under **E-mail Settings**.

System Report

Include (**Included**) or exclude (**Not Included**) certain categories in the system reports that are being sent. The system reports are broken down into different categories such as Generator Energy, Load Energy, etc.

Email Device Report	Activate or deactivate device-specific reporting features. When activated (Yes), device reports are sent electronically to recipients listed in E-Mail Recipients under E-mail Settings .
Email Report Frequency	Change the frequency of reporting by day, week, or month.
Email Report Day	For weekly reporting, choose a day of the week to receive system reports. For monthly reporting, choose whether to receive system reports at the last day of each month or any particular day of the month.
Send Test Report	Test that the E-mail Settings in “Changing E-Mail Settings” on page 3–8 have been configured correctly. Press the  button to send a sample e-mail message to the addresses listed in the E-mail Recipients parameter.

Web

Web	
Parameter	Value
Web Server Access	<input type="text" value="HTTP"/>  
Web Server Port	<input type="text" value="80"/>  

If you want Web access to the Conext ComBox:

- In **Web Server Access**, select **HTTP** and then click .

If you do not want Web access to the Conext ComBox:

- In **Web Server Access**, select **Disabled** and then click .









The default value of the **Web Server Port** is **80**. If this value is changed to **8080**, you must append the URL address with “**:8080**” at the end of the IP address.

Note: You must restart ComBox after changing the **Web Server Port**.

Note: If the Web server is disabled (for example, for security reasons), the Web server will not be available on the next reboot of the Conext ComBox. To regain access to the Web server, “Resetting the Conext ComBox to Factory Settings” is necessary to make configuration changes.

FTP

Note: This setting is for advanced users only.

FTP	
Parameter	Value
FTP User 1 Name	<input type="text" value="firmware"/>  
FTP User 1 Password	<input type="text" value="(New)"/>   <input type="text" value="(Confirm)"/>
FTP User 2 Name	<input type="text" value="logs"/>  
FTP User 2 Password	<input type="text" value="(New)"/>   <input type="text" value="(Confirm)"/>

Use for updating firmware

The **FTP User 1 Name** and **FTP User 1 Password** are used for firmware upgrades. By default, the password is the same as the user name so it must be changed.

Note: For upgrades go to <http://www.sesolar.com/product/conext-combox/>

Use for downloading logs

The **FTP User 2 Name** and **FTP User 2 Password** are used to download log information. By default, the password is the same as the user name so it must be changed.

FTP Logger

This setting allows the user to push event and detected fault logs to an FTP site.

Parameter	Value
FTP Log Enable	<input type="text" value="Disable"/> [Save]
FTP Log Destination Address	<input type="text"/> [Save]
FTP Log Username	<input type="text"/> [Save]
FTP Log Password	<input type="text" value=""/> (New) <input type="text" value=""/> (Confirm) [Save]
FTP Log Destination Directory	<input type="text" value="pub\'"/> [Save]
Test FTP logging [Log]	

FTP Log Enable	Activate or deactivate FTP logging features. When activated (Enable), FTP logs are sent electronically to an FTP site.
FTP Log Destination Address	Specify a valid FTP site.
FTP Log Username	Specify the FTP site's valid user name.
FTP Log Password	Specify the FTP site's valid password in the (New) field. Repeat the password in the (Confirm) field.
FTP Log Destination Directory	Specify a valid directory on the FTP site where all the logs will be stored.
Test FTP Logging	<p>Test that the FTP Logger settings have been configured correctly.</p> <p>Press the  button to send a sample log to the FTP site specified in FTP Log Destination Address.</p>

Note: It is not recommended to select HOURLY data logs when using the FTP logging feature as this will result in only the 11pm data log file being pushed to the FTP server. If you wish to use the FTP logging feature, select DAILY or MONTHLY logging.

Dry Contact Relay

You can set the **Relay Mode of Operation** to **Automatic** so that the relay will automatically turn on if a fault is detected in the system.

Parameter	Value
Relay Mode Of Operation	Automatic

To manually control the mode of operation so that the relay is always on, or always off, select **On** (or **Off**).

Suppress Device Faults/Warnings

You can suppress certain fault and warning codes from being included in the device reports that are sent to **E-Mail Recipients** specified in **E-Mail Settings**.

Parameter	Value
Suppress SCP Faults/Warnings	<input type="text"/>
Suppress AGS Faults/Warnings	<input type="text"/>
Suppress Grid-Tie Faults/Warnings	<input type="text"/>
Suppress XW Faults/Warnings	<input type="text"/>
Suppress CSW Faults/Warnings	<input type="text"/>
Suppress MPPT Faults/Warnings	<input type="text"/>
Suppress HVMPPT Faults/Warnings	<input type="text"/>

List the fault and warning codes for each device you want to exclude in the report by entering the name of the code. Separate multiple codes by comma.

The fault and warning codes for all the devices are usually listed under the Troubleshooting section of the device's Owner's Guide.

Grid-Tie Inverters

For Grid-Tie inverters, enter the following values:

Suppress Grid-Tie Faults/Warnings

Xanbus Communications

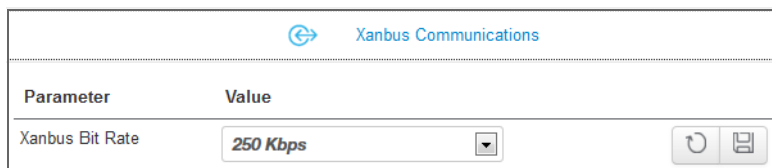

The **Xanbus Bit Rate** parameter for the Conext ComBox has two possible values: 125 and 250 Kbps. The default value for the **Xanbus Bit Rate** is 250 Kbps. XW system devices and components require a 250 Kbps bit rate. You cannot change the bit rate for XW system devices and components. When this setting is changed, reboot the Conext ComBox for the new setting to take effect. See “Rebooting the Conext ComBox” on page 3–14.





















Note: Devices operating on the same bus must have the same bit rate. You cannot operate devices with different bit rates on the same bus.

Grid-Tie Inverters

By default, the Xanbus bit rate is set to 250 Kbps for North American Grid-Tie inverter models and 125 Kbps for European models. If you have a Grid-Tie inverter and want to change the bit rate, make sure you follow the recommended procedure supplied by Schneider Electric: Application Note, “Xantrex Grid-Tie Solar Inverter Baud Rate Change Procedure” (976-0216-01-01). To obtain the Application Note, go to www.SESolar.com, navigate to the product page and then to the downloads.

Note: Remote firmware upgrade using the Conext ComBox is not supported on systems with a 125 Kbps bit rate. If you change the bit rate to 125 Kbps, then you will no longer be able to use the Conext ComBox to upgrade the firmware on Grid-Tie inverters. You will have to upgrade each inverter in the system using an RS-232 cable and a laptop.

Modbus Communications

 Modbus Communications	
Parameter	Value
RS-485 Baud Rate	19200   
RS-485 Parity	E   
RS-485 Stop Bits	1   
Modbus TCP Enabled	Listening   
Modbus TCP Port	502  
Modbus Address	201  
Modbus Byte Order	LSB First   

All of the RS 485 and Modbus settings for the Conext ComBox can be changed as necessary. The default value for the **Modbus TCP Port** is 502 and the **Server Modbus Address** is 201.

Select **Listening** in **Modbus TCP Enabled** to enable Modbus communication.

Note: When writing a character string using function code 0x10 (Write Multiple Registers), the NUL terminator **MUST** be written or the string will not be stored.

When writing 32-bit modbus registers, both 16-bit registers which make up the 32-bit value must be written in order to store the data.

Modbus Byte Order

You can configure the Conext ComBox to change the Modbus byte and word ordering for packed ASCII strings, and 32-bit values. There are two settings for **Modbus Byte Order**:

1. Least Significant byte/word first (**LSB First**)
2. Most Significant byte/word first (**MSB First**)

Select the appropriate setting for your Modbus network.

The following are examples of how the settings operate.

Packed String Example:

When sending the text string "CONEXT" over Modbus:

1. Least Significant byte:



2. Most Significant byte:



32-bit Word Example:

When sending the value 0x12345678 over modbus:

1. Least Significant word:

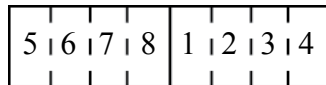

2. Most Significant word:

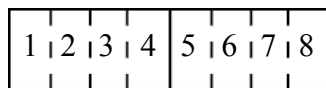

Modbus Address List

Use this function to change the Modbus address of a device. The Conext ComBox automatically assigns addresses when it is installed, but individual values can be changed as necessary. The default addresses are assigned per device type.

Note: To change the initial starting address settings, see “Modbus Address Enumeration”.

The screenshot shows the Schneider Electric Conext ComBox interface. On the left is a navigation tree with categories like System Performance, System Devices, and ComBox Configuration. The main content area is titled 'Modbus Address List' and features a 'Device' dropdown menu currently set to 'BATT_MON'. To the right of the dropdown is an 'Address (1-247)' input field containing the value '1' and a 'Submit' button. Below this is a table titled 'Reserved Addresses' with the following data:

Address	Model	Instance	ID	On Line
1	BATT_MON	0	12	Yes
10	XW (Unknown Model)	0	187073	No
11	XW4024-120240-60	0	20099	Yes
30	XW-MPPT60-150	0	1328371	Yes
70	SCP (Unknown Model)	0	532176	No
90	CSW4024-120240	2	1360826	Yes
110	Grid Tie Inverter	5	835209	Yes
150	FSW (Unknown Model)	0	1361891	No
170	HVMPPT (Unknown Model)	0	838380	No
171	MPPT 80 600	1	838217	Yes

Below the table is a 'Reset Addresses' button. At the bottom of the main area are links for 'Modbus Address Enumeration' and 'System Diagram'. The bottom right corner of the interface shows the date and time: 2014/04/11 20:34.

To change a device Modbus address:

1. In **Settings**, click **Modbus Address List**.

The expanded window displays a table of addresses that are already reserved along with the associated device, its ID and **On Line** status (Yes or No).

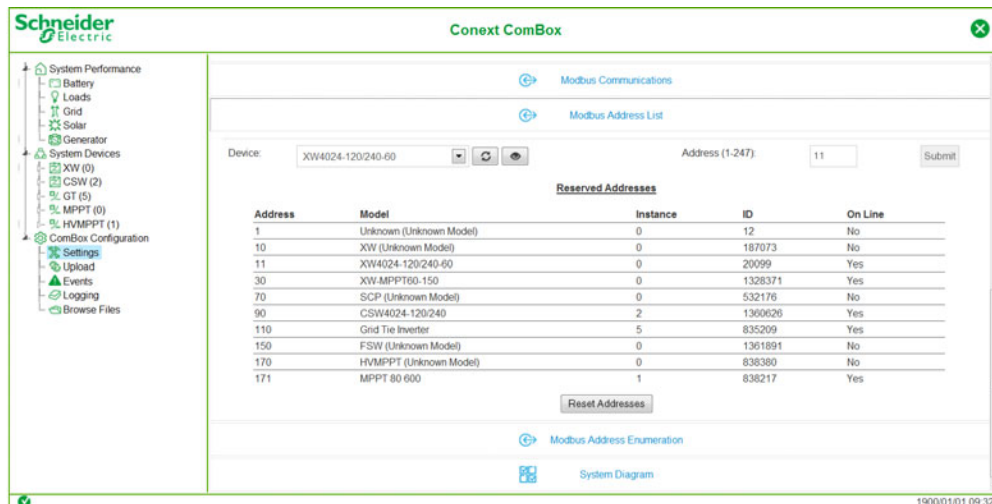

Note: The valid Modbus **Address** is listed from #1 to 247. The rest are assigned special meanings.

2. To change a device Modbus address:

- Select the **Device** from the drop-down list. Its address is displayed in the address box.

If you want to make sure you have selected the correct device:



Click  and a physical indicator on the device will flash, light up, or beep depending on the device.

- Click  to refresh the latest information.
- Enter the new address for the device in the address box. Do not use an address that is already reserved.
- Click **Submit** to save the address change.

To reset all of the device Modbus addresses to their default values:

- ◆ In **Modbus Address List**, click **Reset Addresses**.

Modbus Address Enumeration

↻ Modbus Address Enumeration

Parameter	Value	
XW Modbus Start Address	<input style="width: 150px;" type="text" value="10"/>	<input type="button" value="↻"/> <input type="button" value="💾"/>
MPPT Modbus Start Address	<input style="width: 150px;" type="text" value="30"/>	<input type="button" value="↻"/> <input type="button" value="💾"/>
AGS Modbus Start Address	<input style="width: 150px;" type="text" value="50"/>	<input type="button" value="↻"/> <input type="button" value="💾"/>
SCP Modbus Start Address	<input style="width: 150px;" type="text" value="70"/>	<input type="button" value="↻"/> <input type="button" value="💾"/>
CSW Modbus Start Address	<input style="width: 150px;" type="text" value="90"/>	<input type="button" value="↻"/> <input type="button" value="💾"/>
Grid-Tie Modbus Start Address	<input style="width: 150px;" type="text" value="110"/>	<input type="button" value="↻"/> <input type="button" value="💾"/>
HVMPPT Modbus Start Address	<input style="width: 150px;" type="text" value="170"/>	<input type="button" value="↻"/> <input type="button" value="💾"/>



Use this setting to change the initial starting Modbus addresses for device types. The Conext ComBox automatically assigns starting addresses when it is installed but the starting values can be changed as you wish.

Make these changes before connecting new devices to the Conext ComBox system. When the Conext ComBox detects a new device, it will assign the address based on the current start address setting for that device type. For example, an XW Modbus Start Address of 10:

- The first XW discovered on the network will be assigned the address 10.
- The second XW discovered on the network will be assigned the address 11, and so on.

The starting addresses for each device type on installation of the Conext ComBox are listed above.

To change device type starting addresses:

1. In **Modbus Device Address Enumeration**, click  for the device type to ensure you have the current information.
2. Enter the new starting value for the device type and click .

Note: Valid Modbus addresses can be from 1 to 247. The rest of the numbers are assigned special meanings.

3. Once you have saved all device type starting addresses, there are two options:
 - You can keep the existing device addresses, and the new start address will be applied only to newly discovered devices.

When a new device is detected, the Conext ComBox determines the starting address of that device type, finds the first unused address for that device type, and assigns this address to the new device

- The Conext ComBox can perform a device rediscovery to reassign addresses based on the changed starting addresses.

To reassign new addresses to all devices:

In **Modbus Address List**, click **Reset Addresses**. Then, perform a reboot (see “Rebooting the Conext ComBox” on page 3–14).

System Diagram

System Diagram	
Parameter	Value
Show System Diagram Grid	<input checked="" type="checkbox"/>
Show System Diagram Battery	<input checked="" type="checkbox"/>
Show System Diagram Generator	<input checked="" type="checkbox"/>
Show System Diagram PV	<input checked="" type="checkbox"/>
Show System Diagram Load	<input checked="" type="checkbox"/>

Use this setting to include (checked box) or exclude (unchecked box) system diagrams of each electrical system component as displayed in the System Diagram screen (see Figure 3-2 on page 3–5).

Conext Insight Web Portal

The Conext Insight Web Portal settings control the behavior of the Conext ComBox when Conext Insight has been activated.

The following settings are available on the Conext Insight Web Portal tab:

- The **Enable Data Push to Conext Insight** parameter is checked by default unless it was unchecked when the user first logged in to the Conext ComBox (below the initial disclaimer after the login screen). When checked, the ComBox will share data with the Conext Insight Cloud service.
- The **Enable Data Push Synchronization** parameter must be selected when multiple ComBoxes are present on a site to ensure that the data from each ComBox is pushed to Conext Insight at the same time. If you want all data to arrive at Conext Insight at same time, ensure this box is checked. When using data push synchronization, a **Data Push Synchronization String** must be entered into all ComBoxes and the string must be the same on all Comboxes.

Note: If the **Enable Data Push Synchronization** option is not selected, the Conext Insight view will be inaccurate.







- The **Data Push Synchronization String** can be any standard text or numbers that the user wishes. It is used to synchronize data pushed to the conext insight web portal from multiple ComBoxes.

Note: The **Data Push Synchronization String** must be the same on all ComBoxes connected at the same site.

- The **Test Web Portal Connection** setting is used to test connectivity between the ComBox and Conext Insight. When the Test button is clicked, the **Web Portal Status** icon will indicate whether the Web Portal is active by displaying either a red X or a green checkmark. When **Test** is clicked, it may take a few seconds to perform the test. The **Last Successful Web Portal Data Push** field will also be updated to the current date and time if the test was successful.
- The **Last Successful Web Portal Data Push** field will display the time the last data push was made in the local time at the ComBox.

Multi Cluster

The Multi Cluster settings control the behavior of the Conext ComBox in a Multi Cluster, Multi battery bank configuration.

Multi Cluster	
Parameter	Value
Multi-Cluster Mode	Multicluster Master  
Multi Cluster Group ID	146  
Multi Cluster Port Number	2699  

The **Multi Cluster Mode** configuration drop-down menu allows the user to select a **Stand-alone**, **Multi Cluster Master**, or **Multi Cluster Slave** configuration. The **Multi Cluster Group ID** number specifies the group the ComBox belongs to. The **Multi Cluster Port Number** setting does not need to be changed unless there is another conflicting device on the network with the same port number.

For further information regarding Multi Cluster configuration, refer to the *Combox Multi Cluster Setup Addendum* document available at www.SEsolar.com.

Curtailment

Curtailment refers to periods when the inverter has intentionally reduced its output power. The Curtailment settings control the threshold range within which the ComBox detects whether Curtailment is on or off. When the grid frequency has been raised by a PV inverter, the **Frequency Threshold for Curtailment On Status** and **Frequency Threshold for Curtailment Off Status** fields should match the behavior of the inverter.

Curtailment	
Parameter	Value
Frequency Threshold For Curtailment On Status	60.3 Hz
Frequency Threshold For Curtailment Off Status	60.2 Hz

In a multi-cluster configuration, the current Curtailment status is indicated on the system performance screen beside the Solar Icon as **Curtailment = ON** or **Curtailment = OFF**.

Modbus Master Configuration

The Conext ComBox can serve as a Modbus Master in order to integrate with standard third-party power meters through RS485 Modbus. Modbus Master functionality provides integration with power meters and grid-tie inverters. When enabled, readings for these devices are displayed on the Home screen along with other measurements. Readings are display-only, meaning they cannot be clicked for further information or settings because they remain static.

Devices can be configured from the following setting screens when the Conext ComBox is set up in a master-slave configuration. ComBox firmware version 1.04 and higher is required to run in this configuration.

To configure Modbus Master Settings:

Click the arrow to the left of **ComBox Configuration**, then click **Modbus Master**. The Modbus Master Configuration screen appears.

Communication Setup

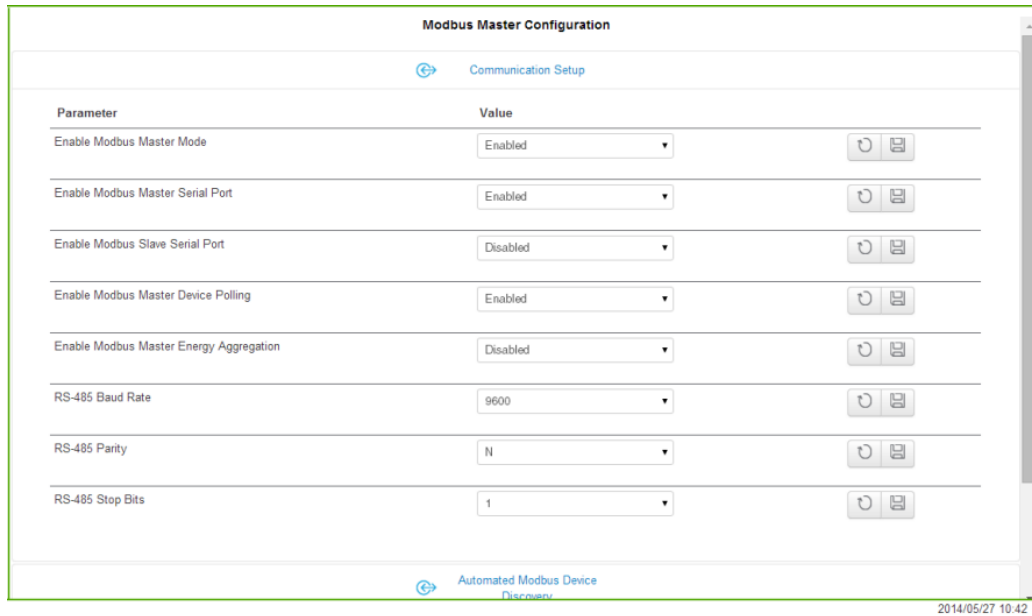

Figure 3-2 Communication Setup Options Screen

Enable Modbus Master Mode toggles the Modbus Master Mode on or off. When enabled, readings for Modbus devices are displayed on the Home screen.

Enable Modbus Master Serial Port toggles the Modbus Master Serial Port Mode on or off. If slave is enabled on the serial port, the master will be disabled because it is not possible to have master and slave on the same hardware port. Also, if the slave serial port is already enabled when the master serial is enabled, the slave serial port will automatically be disabled.

Enable Modbus Master Device Polling when enabled, means that the system is actively sampling the present status of the external devices and polling for information.

The **RS-485 Baud Rate, Parity and Stop Bits** settings can be changed if the serial port settings are different from the defaults displayed - **9600, N, and 1**.

Automated Modbus Device Discovery

The Automated Modbus Device Discovery tool provides start and end address range fields to perform a search for devices connected through Modbus. Limit this range if you know that your device falls within a specific range or if you already know the address. Limiting the range will speed up the discovery tool significantly.

Press **Discover** to display a list of devices.

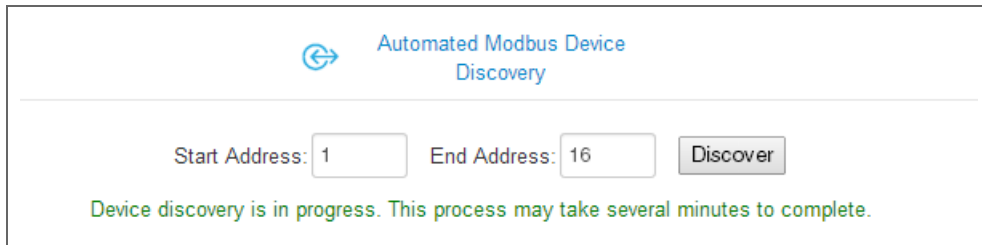

The screenshot shows a web interface titled "Automated Modbus Device Discovery". It features a blue refresh icon and the title. Below the title, there are two input fields: "Start Address:" with the value "1" and "End Address:" with the value "16". To the right of these fields is a grey button labeled "Discover". Below the input fields, a green message states: "Device discovery is in progress. This process may take several minutes to complete."

The tool refreshes the **Modbus Device List** as it searches, displaying the address and type of device. The tool will also search slave devices, displaying the address and type of the slave device.

Supported Devices

The Conext ComBox supports the following devices using the The Automated Modbus Device Discovery tool:

- PM810 Power Meter
- PM820 Power Meter
- PM850 Power Meter
- PM870 Power Meter
- Conext RL Inverter
- Conext TL Inverter
- Conext CL Inverter

Manually Add Device

If the Automated Modbus Device Discovery tool doesn't display your device, you can manually add it by entering the address and selecting the device type from the drop-down menu.

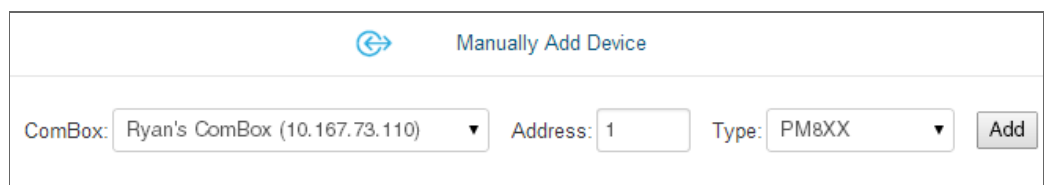

The screenshot shows a web interface titled "Manually Add Device". It features a blue refresh icon and the title. Below the title, there are three input fields: "ComBox:" with a dropdown menu showing "Ryan's ComBox (10.167.73.110)", "Address:" with the value "1", and "Type:" with a dropdown menu showing "PM8XX". To the right of these fields is a grey button labeled "Add".

Only the devices listed in "Supported Devices" on page 3–33 can be manually or automatically added.

Modbus Power Meters

Press the Refresh button to display the power meters connected via Modbus.

ComBox	Meter	Address	Association	Assign
Sam's ComBox (10.167.73.145)	PM8XX	10	Loads	Assign
Sam's ComBox (10.167.73.145)	PM8XX	11	Grid	Assign

The **Association** drop-down menu will correspond with where the power meters appear on the System Performance screen. For example, if **Loads** is selected from the drop-down menu, the power meter will appear between the **Devices** icon and the **Loads** icon.

Modbus Device List

Displays a list of currently active Modbus devices, displaying the ComBox device where the device is located, the address and type of device.

ComBox	Address	Type
Ryan's ComBox (10.167.73.110)	4	SMP3

Resetting the Conext ComBox to Factory Settings

If you need to return the Conext ComBox to all of the original factory settings, you can perform a factory reset.

To reset the Conext ComBox to original factory settings:

1. Turn off the Conext ComBox by shutting it down properly (as shown on page 3–14) and then disconnecting all its power sources. Make sure the Power LED is off. Wait ten seconds before the next step.

To turn the unit on, insert a pointed object such as a paper clip into the Reset pinhole, and press the button while reconnecting the Conext ComBox's power source.

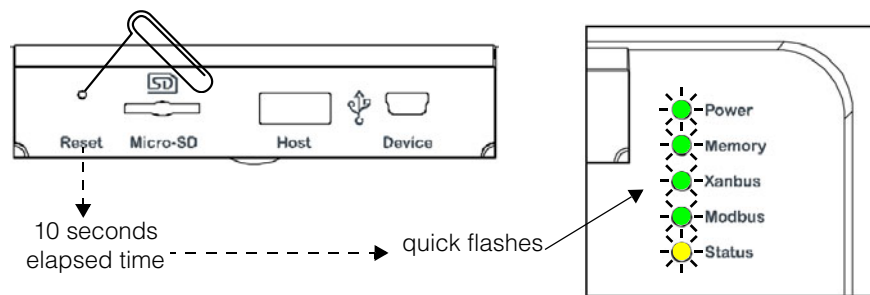

2. Continue pressing (holding) the Reset pinhole button until all indicator LEDs flash quickly five times (approximately 10 seconds) then immediately release the button.

Note: Do not hold the reset button too long after observing the quick flashes. When you observe that the indicator LEDs have begun flashing slowly, the internal firmware memory will have already been cleared. There is no way to undo this except to do an upgrade. See “Upgrading Firmware” on page 3–42.

Note: The Power LED flashes slowly during the Conext ComBox application loading and flashes quickly during application initialization. The other LEDs turn on as the startup progresses. This process takes about two minutes.

3. When the reset is complete, the Power indicator stays on to indicate the Conext ComBox is ready.

Note: It is also possible to reboot the ComBox without performing a full reset to factory settings. When the green power light is illuminated, simply press and immediately release the reset button to reboot and keep the existing settings.

Changing Device Settings

Before making any changes, familiarise yourself thoroughly with the effects of changing the power system settings.

NOTICE

EQUIPMENT DAMAGE

- Consult the device's Owner's Guide when changing the device's settings.
- Make sure the device connected on the Xanbus or Modbus network is in standby mode before changing settings.
- Do not change any settings unless you are familiar with the device.

Failure to follow these instructions can damage equipment.

To set a device in Standby mode:

1. Click the  System Devices icon in the left panel to show all Xanbus devices in the network. Depending on your system, there may be several devices shown.
2. Find the device you want to change from the Device Quick Settings screen.

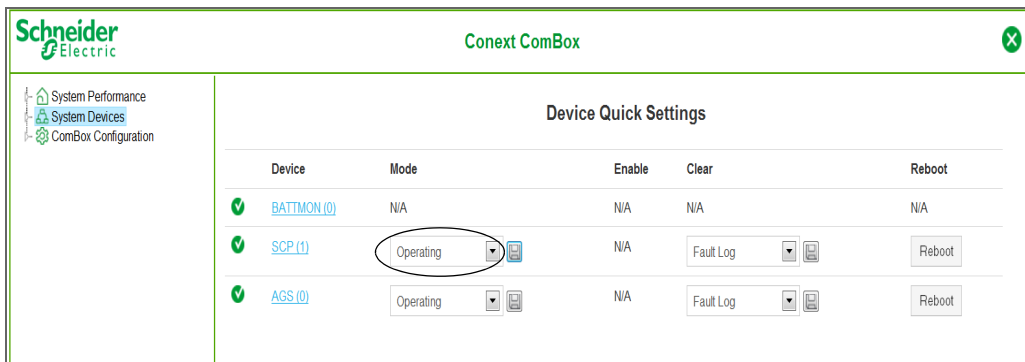



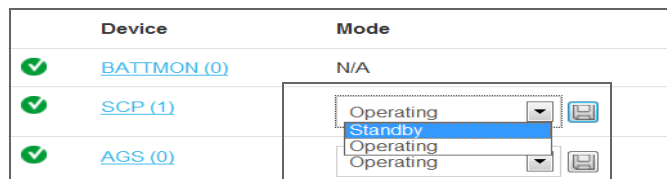

3. Click the down arrow for the drop-down menu and change the Operating Mode parameter to Standby.



4. Click  to save the setting.

To change a Device Setting after putting the device on Standby:

1. After putting a device on Standby mode, proceed to change the device's other settings. Each Xanbus device will have varying settings which correspond to that device. Be sure to consult the device's Owner's Guide before trying to change the settings via the Conext ComBox.
2. Click  System Devices from the left panel, then click the device you wish to change.
3. Click the  Settings button of the device you wish to change to open the Device Settings page.
4. The Device Settings are separated into categories. Click the category of the setting you wish to change from the main window to expand the settings page.
5. In the expanded window, click  to update the current setting from the device. This may be different from the value shown if the change was made without the ComBox – for example, if another device like the SCP was used to change the value.
6. Modify the value(s) as necessary.
7. Click  to save the change(s).

Cascading Parameters and Copy Configuration Features



Using Cascading Parameters

Xanbus-enabled devices are typically configured one at a time. However, because devices often have common settings, cascading parameters can simplify and speed up system configuration. When a parameter is “cascaded,” a newly configured device setting on one device is applied to all devices of the same device type on a common AC or DC connection.

Table 3-1 shows which device settings are able to be cascaded. Once cascading parameters are enabled, any change to a device setting in listed in Table 3-1 will be automatically applied to all devices of the same type.

For example, if cascading parameters are enabled and a Battery Size (Ah) parameter is changed on the XW inverter setup menu, the same battery size setting is applied to other XW inverters.

To enable or disable cascading parameters:

1. Put the device on standby mode. See “To set a device in Standby mode:” on page 3–36.
2. Click  System Devices to access the individual devices menu.
3. Click the device you want to configure.
4. Click  Settings from the menu tree below the highlighted device.

You will see a list of **Device Settings** for the device.

Note: Device settings for each Xanbus device vary and may not contain the Cascading Settings option. Be sure to consult the Owner’s Guide of the device before trying to change the settings via the Conext ComBox. Also, when configuring the network-managed power system with cascading parameters enabled, you should verify that the configurations have been cascaded correctly to other devices. Communication errors may cause parameters to revert to their original values or generate a warning message.

5. Click  Multi-unit Configuration to expand the device setting.

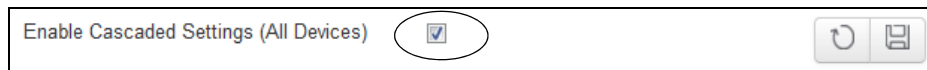



6. Click the Enable Cascaded Settings (All Devices) check box to enable the setting. If the box is already checked then cascading is already set up and no further action is required.
7. Click  to save the change.

Using Copy Configuration

The copy configuration feature allows you to copy all device settings described in Table 3-1 from one device to another device of the same type on a common AC or DC connection.

To copy parameter settings from one device to another device of the same type:

1. Put the device on standby mode. See “To set a device in Standby mode:” on page 3–36.
2. Click  System Devices to access the individual devices menu.
3. Click the device you want to configure.
4. Click  **Settings** in the left side menu.

You will see a list of **Device Settings** for that type of device.

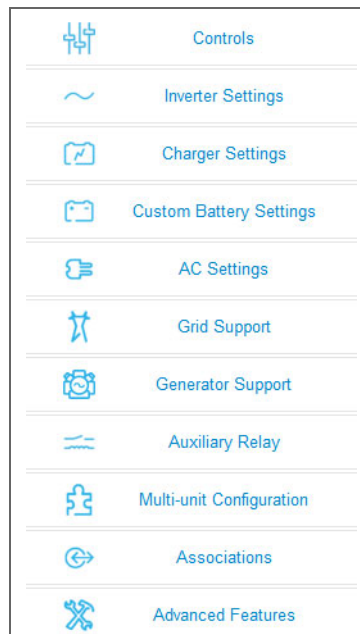

Note: Device settings for each Xanbus device vary. The one shown here is for the Conext XW+ inverter. Be sure to consult the Owner’s Guide of the device before trying to change the settings via the Conext ComBox.

Also, when configuring the network-managed power system with cascading parameters enabled, you should verify that the configurations have been cascaded correctly to other devices. Communication errors may cause parameters to revert to their original values or generate a warning message.

5. Click  **Multi-unit Configuration** to expand the device setting.
6. From the drop-down box, select the device to which you want to copy the settings.



7. Click  to copy the settings.

Table 3-1

Parameter	Cascade	Copy
SearchMode	No	Yes
Grid Support	Yes	Yes
Battery Voltage	Yes	Yes
Battery Type	Yes	Yes
Battery Capacity	Yes	Yes
Max Charge Rate	Yes	Yes
Charge Cyle	Yes	Yes
ReCharge Volts	Yes	Yes
Absorb Time	Yes	Yes
Dft Batt Temp	Yes	Yes
EqLz Support	Yes	Yes
EqLz Voltage	Yes	Yes
Bulk Voltage	Yes	Yes
Absorb Voltage	Yes	Yes
Float Voltage	Yes	Yes
Batt Temp Comp	Yes	Yes
ChgBlockStart	Yes	Yes
ChgBlockStop	Yes	Yes
Lo Batt CutOut	Yes	Yes
LBCO Delay	Yes	Yes
Hi-Batt Cut-Out	Yes	Yes
Search Watts	Yes	Yes
Search Delay	Yes	Yes
AC Priority	Yes	Yes
AC1 Breaker	Yes	Yes
AC1 Lo Volts	Yes	Yes
AC1 Hi Volts	Yes	Yes
AC1 Lo Freq	Yes	Yes
AC1 Hi Freq	Yes	Yes
AC2 Breaker	Yes	Yes
AC2 Lo Volts	Yes	Yes
AC2 Hi Volts	Yes	Yes
AC2 Lo Freq	Yes	Yes
AC2 Hi Freq	Yes	Yes
Grid Supp Volts	Yes	Yes
Max Sell Amps	Yes	Yes
Load Shave	Yes	Yes
Load Shave Amps	Yes	Yes
Load Shave Start	Yes	Yes
Load Shave Stop	Yes	Yes
GenSup Mode	Yes	Yes

Table 3-1

Parameter	Cascade	Copy
GenSup Amps	Yes	Yes
LowBattV (Trigger Level)	Yes	Yes
LowBattV (Trigger Delay)	Yes	Yes
LowBattV (Clear Level)	Yes	Yes
LowBattV (Clear Delay)	Yes	Yes
HighBattV (Trigger Level)	Yes	Yes
HighBattV (Trigger Delay)	Yes	Yes
HighBattV (Clear Level)	Yes	Yes
HighBattV (Clear Delay)	Yes	Yes
Connections (AC1)	No	Yes
Connections (AC2)	No	Yes
Connections (AC Out)	No	Yes
Connections (DC Conn)	No	Yes

Upgrading Firmware

You can perform firmware upgrades for your Conext ComBox and Xanbus-enabled devices when they are available for download. You can download them from the Schneider Electric Conext ComBox website at <http://www.sesolar.com/product/conext-combox/> to a mass storage device, such as a thumb drive, or to a computer that you then connect to the Conext ComBox.

Note: It is recommended you clear the internal firmware memory of the Conext ComBox before installing Conext ComBox firmware upgrades.

Clearing Conext ComBox Internal Firmware Memory

Note: Clearing internal firmware memory should be done for Conext ComBox upgrades only. It is not necessary for upgrades to other devices on the network.

To clear the Conext ComBox internal firmware memory:

1. Turn off the Conext ComBox by shutting it down and disconnecting all its power sources. Make sure the Power LED is off. Wait ten seconds before the next step. Insert a pointed object such as a paper clip into the Reset pinhole and press the button while turning on the Conext ComBox by reconnecting to its power source.

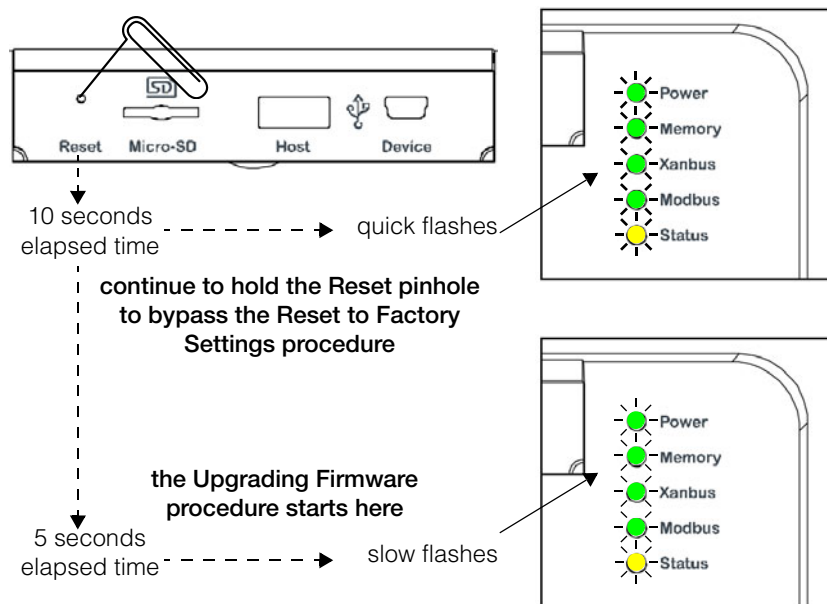

2. Continue pressing (holding) the Reset pinhole button until all indicator LEDs flash quickly five times (approximately 10 seconds). Continue to hold the button until the LEDs flash slowly (approximately 5 seconds).

When the memory has been cleared, the Status and Power LEDs are on and a firmware upgrade must be done.

Installing Conext ComBox Upgrades from a Thumb Drive

To install an upgrade for the Conext ComBox using a thumb drive:

1. Connect the thumb drive to a computer with Internet access.
There must be only one **.bdl** file on the thumb drive. If there are two or more **.bdl** files, there is no guarantee which **.bdl** file will be chosen.
2. In a Web browser, go to <http://www.sesolar.com/product/conext-combox/> to select the upgrade you need.
3. Once you have found the upgrade, save the **.bdl** file to the root directory of the thumb drive.

Note: Save the **.bdl** file to the root directory of the thumb drive so the upgrade can install properly.

4. Clear the Conext ComBox internal memory. See “Clearing Conext ComBox Internal Firmware Memory”.

Connect the thumb drive to the USB port labeled Host on the top front of the Conext ComBox.

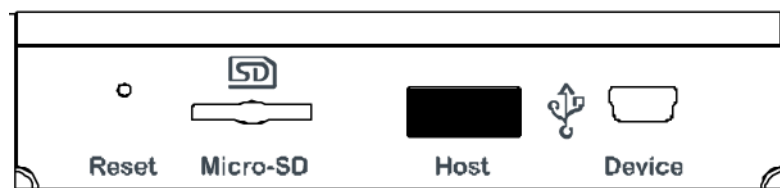

The firmware upgrade begins automatically.

5. Watch the indicator LEDs on the Conext ComBox. When the Xanbus LED goes on, it is now okay to remove the thumb drive.
As the upgrade progresses the Power LED flashes. The other LEDs go on to indicate the upgrade process. This can take several minutes depending on the size of the upgrade.
6. When the upgrade is complete, the Power LED is on to indicate that the Conext ComBox is ready.
7. Clear your computer's web browser cache after the upgrade before you log back in to the Conext ComBox's web user interface.

Clearing a web browser's cache

To clear the web browser's cache:

1. In PC-based web browsers, press the keyboard shortcut **CTRL** - **SHIFT** - **DEL** .
2. In the dialog box that opens (varies for each web browser), select an option to clear temporary Internet files or “cache”. See examples in Figure 3-3 and Figure 3-4 on page 3-44.
3. For Mac's Safari web browser, you have to go to Preferences and then to Security.

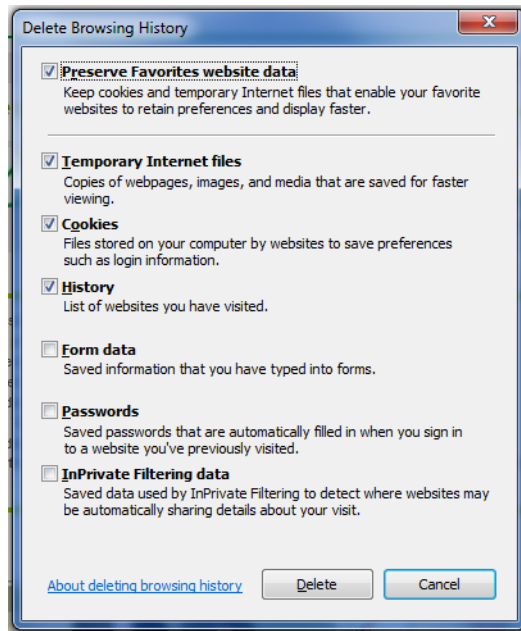

Figure 3-3 Internet Explorer Delete Browsing History

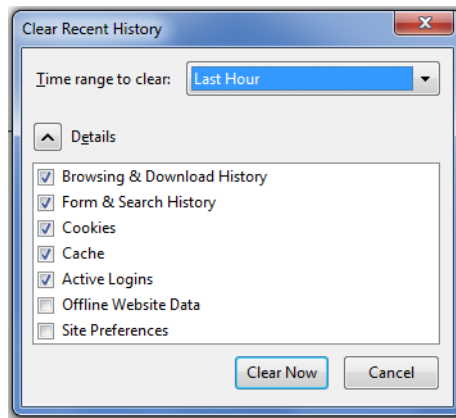



Figure 3-4 Firefox Clear Recent History

Installing Conext ComBox Upgrades Remotely

Note: Your web browser may not support the upgrade function. Use Chrome 18.x or later, IE 10.x or later, Firefox 12 or later, or Safari 5.x or later for Conext ComBox upgrades.

To install a Conext ComBox upgrade remotely:

1. In a web browser, go to <http://www.sesolar.com/product/conext-combox/> to select the Conext ComBox upgrade you need.
2. After you find the upgrade, save the .bdl file in a local directory.
3. In your web browser, connect to your Conext ComBox.
4. Log in to the Conext ComBox web user interface with your user name and password.
5. In the menu bar, click the arrow to the left of  ComBox Configuration to expand the menu.
6. Click  Upload from this menu.
7. In File under File Uploads to Conext ComBox, click the field box to select the .bdl file (*factory.bdl*) you saved in a local directory from the Schneider Electric website.

Firmware Uploads And Device Upgrades

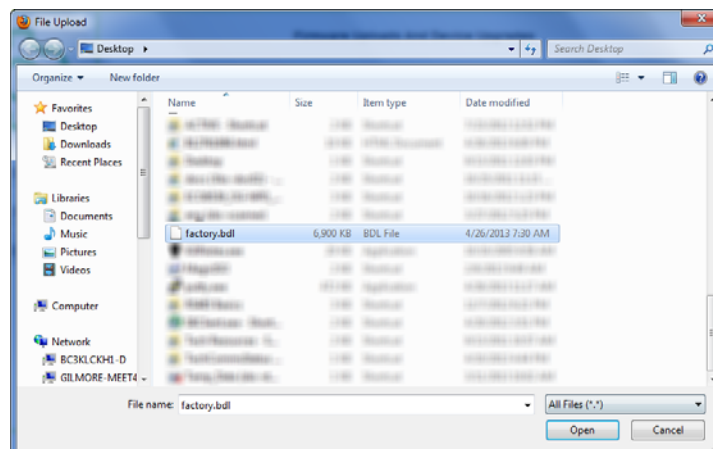
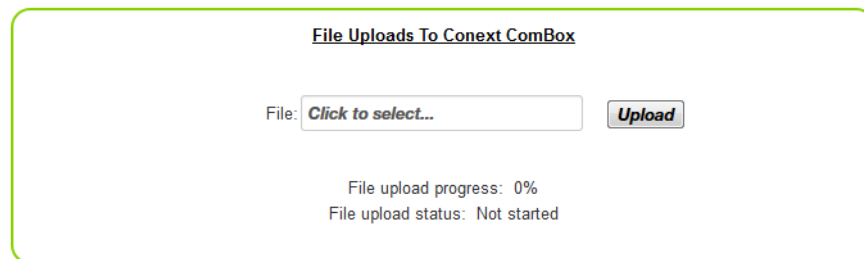

8. Click **Upload**.

You are automatically prompted with a warning dialog box. Click OK.

As the bundle is transferred to the Conext ComBox, progress is indicated in percentage, and a message screen indicates when the file transfer has been completed successfully.

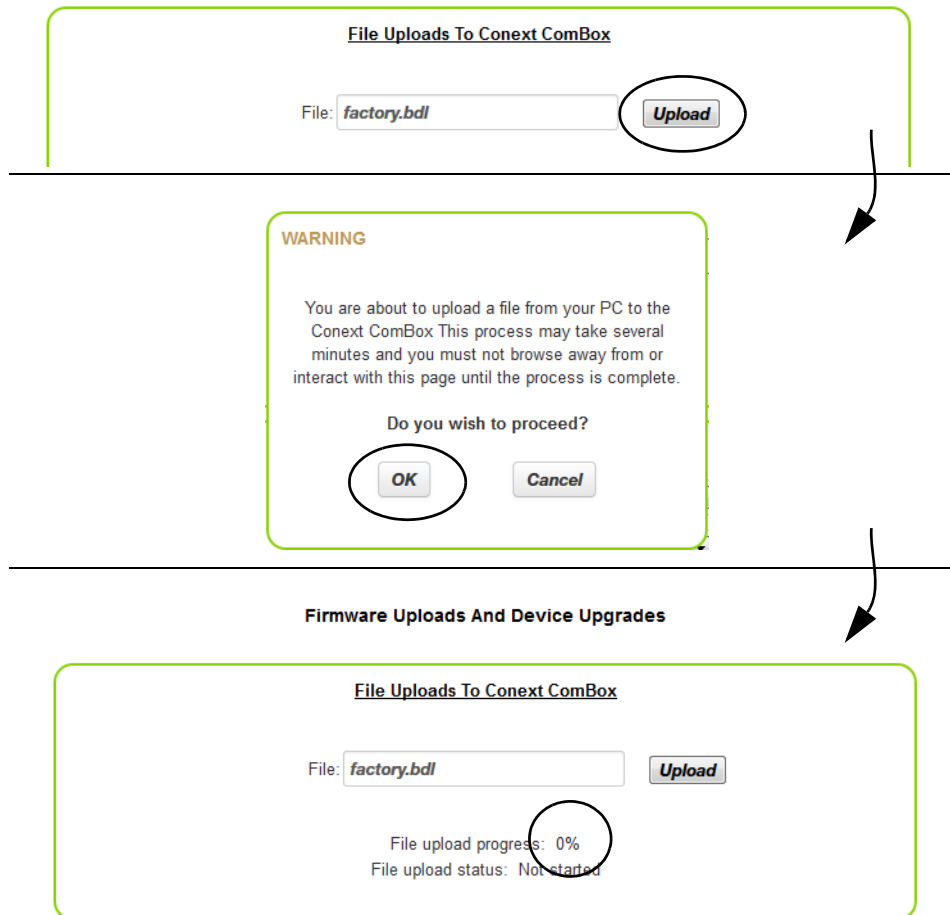

When the bundle file has transferred to the Conext ComBox, the files in the bundle are automatically extracted and reprogramming of the Conext ComBox begins.

The Conext ComBox update will show a series of update progress screens similar to what is shown in the next page.

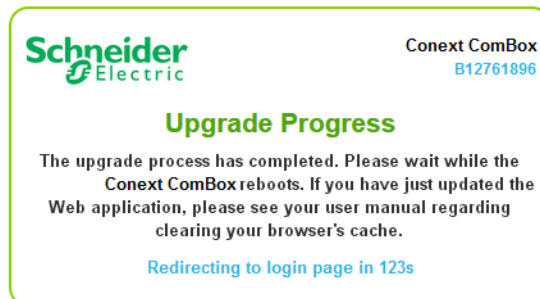
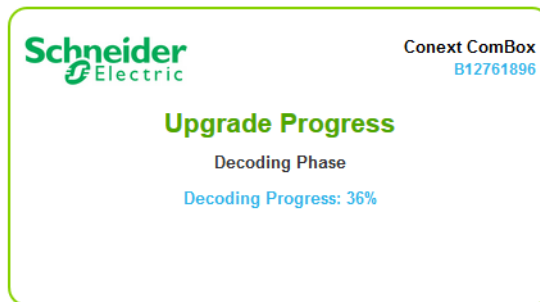



9. Clear your computer's web browser cache after the upgrade before you log back in to the Conext ComBox's web user interface. See "Clearing a web browser's cache" on page 3–43.
10. Reboot the Conext ComBox. See "Rebooting the Conext ComBox" on page 3–14.

Bootloader Upgrade

What happens when a new bootloader is included in the upgrade file?

It is possible that the bundle file may also contain a bootloader upgrade file. To find out, you need to log back in and follow these instructions.

1. In your web browser, connect to your Conext ComBox.
2. Log in to the Conext ComBox web user interface with your user name and password.

3. In the menu bar, click the arrow to the left of  ComBox Configuration to expand the menu.
4. Click  Upload in the left side menu. If a new bootloader is included in the bundle file, you are automatically prompted to update the Conext ComBox bootloader.

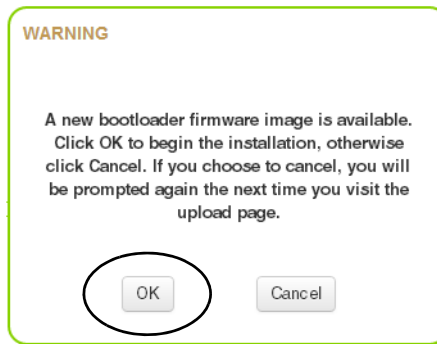

When you click OK, you will see a series of bootloader upgrade progress screens similar to what is shown in the next page.

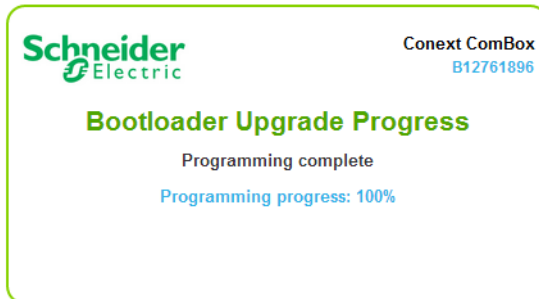

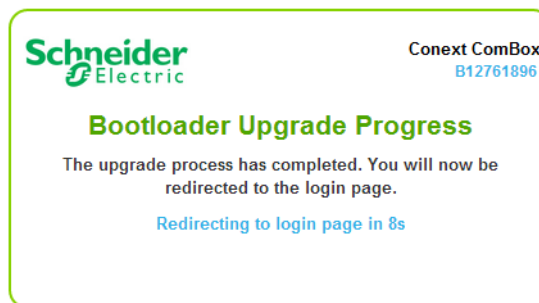

After the bootloader upgrade is complete, the Conext ComBox restarts automatically.

5. Clear your computer's web browser cache after this upgrade before you log back in to the Conext ComBox's web user interface. See "Clearing a web browser's cache" on page 3–43.

Installing Xanbus Device Upgrades

You can upgrade firmware for specific Xanbus-enabled devices remotely or from a computer connected to the Conext ComBox with the USB cable supplied.



Note: Your Web browser may not support the upgrade function. Use Chrome 18.x or later, IE 10.x or later, Firefox 12 or later, or Safari 5.x or later for Conext ComBox upgrades.

To install upgrades for Xanbus devices connected to the Conext ComBox:

1. In a Web browser, go to <http://www.sesolar.com/product/conext-combox/> to select the device upgrade that you need.
2. Once you have found the upgrade, save the .xf0 file in a local directory.

Note: Do not change the .xf0 file name unless it is for a Grid-Tie inverter.

For a GT .xf0 file you must prefix the file name with 867.0001, for example, 867.0001.filename.xf0

3. In your Web browser, connect to the Conext ComBox.
4. Log in to the Conext ComBox web user interface with your user name and password.
5. Click the arrow to expand  **ComBox Configuration** in the menu tree.
6. Click  **Upload** in the menu tree.
7. Under **File Uploads to Conext ComBox**, click in the **click to select** field to select the .bdl file you saved from the Schneider Electric website.

- Once the file is successfully transferred to the Conext ComBox, go to the **Xanbus Device Upgrades** section.

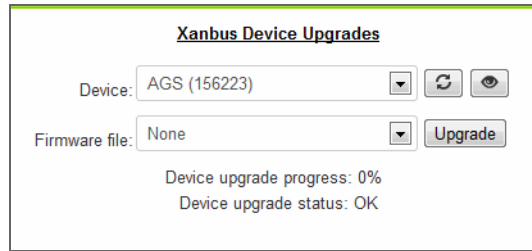

Xanbus Device Upgrades

Device: AGS (156223) [Refresh] [Eye]

Firmware file: None [Upgrade]

Device upgrade progress: 0%

Device upgrade status: OK

- In **Device**, click  to load the latest list of devices.
- Select the **Device** you want to upgrade from the drop-down list.

You can click  to confirm you have selected the device you want. When this icon is clicked, a visual and/or audio indicator on the selected device will flash.

- In **Firmware file**, select the **.xf0** file for the device upgrade.
- Click **Upgrade**.

Device upgrade progress is indicated in percent and **Device upgrade status** is **OK** when the upgrade has completed successfully.

If the device upgrade is not successful, click **Upgrade** again to retry.

If retrying does not work:

- Do a power cycle of the Xanbus device that is being upgraded.
- Retry clicking **Upgrade** on the web interface.

NOTICE

EQUIPMENT MALFUNCTION

Certain devices such as the Conext Battery Monitor can take longer than others to upgrade.

Always allow time for the device upgrade to complete. Do not power cycle the device if the upgrade is still in progress.

Failure to follow these instructions can damage equipment.

Conext ComBox Master-Slave Configuration

Overview

The ComBox can be set up in a master-slave configuration to monitor multiple separate Xanbus networks and supported Modbus devices, such as power meters. This configuration can be used for large multi-cluster systems as well as smaller systems when devices need to exist on separate ComBoxes.

Using a Master-Slave Configuration, multiple Xanbus networks on separate ComBoxes can be combined and monitored through the Master ComBox. When multiple ComBoxes have been added to the system, the settings of the slaves can be controlled and modified by the Master ComBox. Data is reported by the Slave ComBox to the Master ComBox. The Master ComBox is for data aggregation only and has no Xanbus or Modbus devices attached directly. RS-485 devices and principal devices such as XW+, AGS, SCP, etc. are placed on one of the slave ComBoxes.

A sample master-slave configuration is provided below.

Note: This diagram is an example for illustration purposes only and is one of many possible configurations.

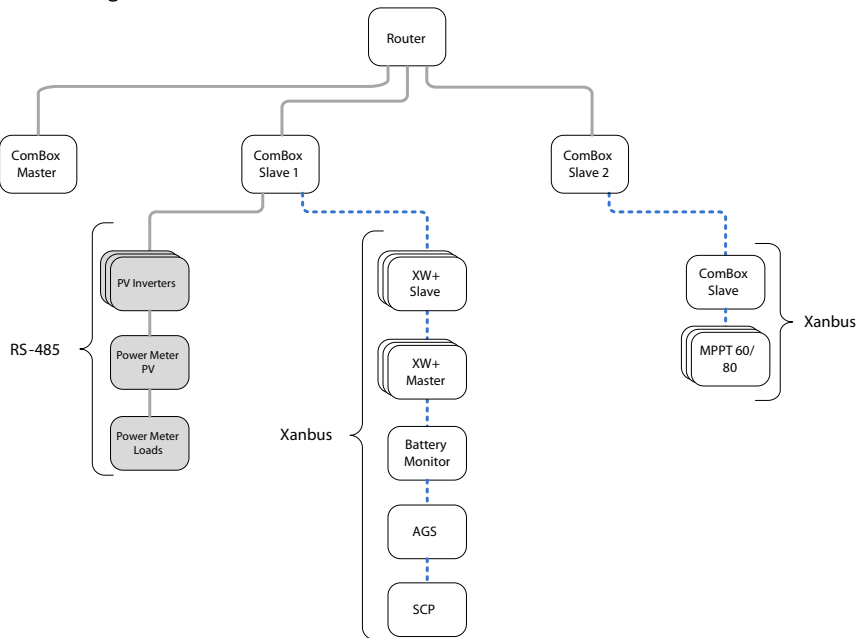

Figure 3-5 Example Master-slave Configuration

Note: Compatibility between different firmware versions in a Master/Slave system is not guaranteed. Therefore, ensure the same firmware version is installed on all ComBoxes in a Master/Slave system.

4

Monitoring

Chapter 4 describes the many ways the Conext ComBox can monitor system components. Topics include:

- Monitoring LEDs
- Monitoring Conext ComBox Status Information
- Daily Summary Plots
- Remote Monitoring With Conext Insight

Monitoring LEDs

LED indicators allow you to monitor the functioning of the Conext ComBox. There are five LEDs in the upper right corner of the Conext ComBox:

- Power
- Memory
- Xanbus
- Modbus
- Status

All LED indicators are green except the amber Status indicator.

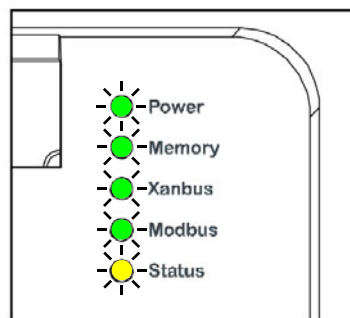

Startup

The Power LED flashes slowly when the Conext ComBox application is loading and flashes quickly during application initialization. The other LEDs illuminate as startup progresses. Once the Conext ComBox is ready, the Power LED turns on steadily. This process takes about two minutes.

Operating Mode



The LED states and descriptions are listed in the following table.

Indicator	State	Description
Power	On	Powered and ready to communicate
	Flashing	The Conext ComBox is rebooting
Memory	Flashing	Logging data to internal memory
Xanbus	On	Actively communicating or transferring data with the Xanbus network
Modbus	Flashing	Receiving messages from a Modbus master, one flash per message
Status	On	Checking the status on a Xanbus device or the Conext ComBox. Checking the web user interface status screen to identify the current state of the device or checking the e-mail for reported faults

Monitoring Conext ComBox Status Information

You can view the current settings for the Conext ComBox without making changes.

To view Conext ComBox Status Information:

1. In the menu tree, click the arrow to the left of  ComBox Configuration to expand the menu.
2. Click  **Settings** in the left side menu. The screen below appears.



3. Click the setting type you want to view.
The selected setting expands to display the options for that setting as shown in the following screen. The size and content of the expanded window varies depending on the setting type.

To view Conext ComBox Status Information in a Master-Slave configuration:

1. In the menu tree, click the arrow to the left of  ComBox Configuration to expand the menu.
2. Click the ComBox you wish to view. The Master ComBox will be indicated by (Master) preceding the ComBox name.
3. The ComBox Status Information page will appear as in the example below. Click the individual items to reveal their corresponding menus:

The screenshot displays three sequential screens from the Conext ComBox status information interface. The top screen, titled "Conext ComBox Status Information", contains three menu items: "Modbus Address List" (with a refresh icon), "Web Application Version" (with an information icon), and "Conext ComBox Version" (with an information icon and a mouse cursor). The middle screen shows a table with two columns: "Field" and "Value". The bottom screen, titled "Device Information", displays a list of device details and a note.

Field	Value
Version	1.3.9139
Build Date	2013/05/04 10:03:54

Field	Value
Application Version	Ver01.01BN9139
Application Build Date	2013-05-04_10-03-27
Bootloader Version	Ver01.01BN0052
Bootloader Build Date	2013-04-29_16-19-05

Note: The information displayed in these examples will be different from those in your Conext ComBox.

Device Info: Conext ComBox by Schneider Electric

Model Number: 865-1058
Serial Number: B12761900
Hardware Revision: Rev-C

Device Name: ComBox B12345678

MAC Address: 00:00:54:fe:01:1b
IP Address: 10.167.73.66
Hostname: cb-B12761900

Software ID: 150-0279
Kernel Version: 1.18

Application Version: Ver01.01BN9139
Application Build Date: 2013-05-04_10-03-27

Boot Loader Version: Ver01.01BN0052
Boot Loader Build Date: 2013-04-29_16-19-05

Modbus Map Version: A.1

Date and Time: 2013/05/07 14:18:34
Time Zone: (-08:00)Pacific-Time_US_Canada_Tijuana

Figure 4-1 Conext ComBox Status Information Example Screens

Daily Summary Plots

Daily Summary Plots provide an at a glance look at daily Power activity. Daily Summaries are available for PV and AC power which display Load Power, Grid Net Power, AC Generator Power, and PV Harvest Power. It is also possible to view and combine battery bank data such as battery voltage, current, SOC, and

temperature using the Battery Bank Daily Summary Plot. Individual plots for these inputs are customizable and can be displayed or not displayed as required for comparison purposes.

PV & AC Daily Summary Plot

The PV & AC Daily Summary Plot displays readings for **Load Power**, **AC Generator Power**, and **PV Harvest Power**. The display for each plot can be toggled by clicking on the corresponding title in the graph legend. Clicking the title will cause it to be greyed out and the corresponding plot will be removed from the graph. Clicking again will restore the plot to the graph.

Load Power

Displays the wattage of power consumed by the loads for the period plotted.

Grid Net Power

Displays the total wattage of power exported or imported to/from the grid for the period plotted.

AC Generator Power

Displays the wattage of power input from the generator for the period plotted.

PV Harvest Power

Displays the wattage of power input from all PV sources for the period plotted.

Battery Bank Daily Summary Plot

To plot a specific combination of data from different battery banks, use the **Series** drop-down menus to select the four values to plot, then click the **Plot Selected Series** button to update the plot. The display for each plot can be toggled by clicking on the corresponding title in the legend. Clicking the title will cause it to be greyed out and the corresponding plot will be removed from the graph. Clicking again will restore the plot to the graph.

Selecting a Battery Bank from the **Battery Bank to Plot** drop-down menu will automatically display the voltage, current, SOC, and temperature of the selected Battery Bank for the date selected in the **Date to Plot** drop-down menu. If menu items for different banks are selected from the **Series** drop-down menus, they will automatically be changed to the bank number of the selected bank in order to show readings for the entire bank.

Navigating and Zooming Plots

To view individual data points within the Daily Summary Plots:

To view individual data points within the plot, mouse over the position on the plot you would like to view and the cursor automatically snaps to the nearest data point. The reading at the specific location will appear beside a diamond shaped cursor, indicating the values for that data point.

To zoom in a specific area of the Summary Plot:

To zoom in on an area of the plot, click and hold the mouse button to draw a square around the area to zoom. When the mouse button is released, the zoomed area is displayed and the corresponding plot values are updated.

To reset the zoom level after zooming in:

Whenever the plot has been zoomed, a button labelled Reset Zoom will appear over the graph area. Click this button to return to the highest zoom level.

Remote Monitoring With Conext Insight

The Conext Insight remote monitoring solution allows the user to monitor their site(s) remotely. Conext Insight offers a simple, accessible and intuitive solution for site monitoring with the added benefit of improved data integrity on a backup server.

To enable remote monitoring with Conext Insight, first configure the remote monitoring settings in the ComBox (see “Conext Insight Web Portal” on page 3–32 of this guide). Then, create and activate an account on the Conext Insight Web Portal and register your site (Refer to the *Conext Insight Owner’s Guide* for details).

5

Troubleshooting

Chapter 5 describes event and alert indicators and resolutions to issues that might be encountered when installing or operating the Conext ComBox. It includes:

- Viewing Xanbus Device Faults and Warnings
- Viewing ComBox Events
- Viewing System Faults and Warnings
- Browsing Event and Fault Log Files
- Browsing Energy Log Files
- Troubleshooting
- Managing Data Logs

Viewing Xanbus Device Faults and Warnings

If the Devices or Clusters icon on the Conext ComBox home screen is flashing red or orange, it indicates that one or more Xanbus devices has a fault (red) or warning (orange).

To determine the cause of a fault or warning:

1. Expand System Devices (or in a Multi-cluster configuration, Cluster Summary) in the left side menu tree.
2. Click the device or cluster with the fault or warning you want to examine. In this example, click Cluster 2 with the fault (red).
3. Click  beside the device name to view the active fault/warning. The “Today’s Events” screen appears with event types selectable through the Event Type drop-down menu. The event ID, name, and time of occurrence are displayed.
4. Select the Event Type. You can choose one of these options: Active Faults, Historical Faults, Active Warnings, or Historical Warnings. In the following example, Active Faults has been selected to get a list of the current active faults.
5. Mouse over the fault name to get a detailed description of the fault.

Viewing ComBox Events

You can use the system event list to troubleshoot ComBox operation. The system event list only shows events from today.

1. Expand **ComBox Configuration** in the left side menu tree.
2. Click **Events** in the left side menu.
3. Select **Events** from the System Event Type drop-down.

The screenshot shows the Schneider Electric Comnext ComBox interface. The left sidebar contains a navigation tree with the following items: System Performance, System Devices, XW (0), Meters, Settings, Events, ComBox Configuration, Settings, Upload, Events, Logging, Browse Files, and Modbus Master. The 'Events' item under 'ComBox Configuration' is selected. The main area is titled 'System Events' and features a dropdown menu for 'System Event Type' set to 'Events'. Below the dropdown is a table of system events.

Time	Description
20140501 09:53:08	Login: admin
20140501 09:52:48	Login: admin
20140501 09:52:32	Created Xanbus Device: XW (2032607)
20140501 09:52:25	System Startup - Application Version: Ver01.03BN0542
20140501 09:52:25	Network Cable Connected
20140501 09:45:21	Started uploading ram 0 factory bin
20140501 09:45:15	File Transfer Session Ended
20140501 09:44:11	Login: admin
20140501 09:24:40	Login: admin
20140501 03:07:03	Created Xanbus Device: XW (2032607)
20140501 03:06:55	System Startup - Application Version: Ver01.03BN0541
20140501 03:06:55	Network Cable Connected
20140501 03:05:00	System Reboot requested by reboot command - rebooting in 5 seconds

The events are listed in reverse chronological order, with the newest on top. Use the scroll bar to navigate through the list.

Note: System events show only the events for the current day. If you want to view system events from previous days, use the file browser navigator.

Viewing System Faults and Warnings

You can use the Faults and Warnings event list to troubleshoot the ComBox and Xanbus device operation. The list displays all faults and warnings with timestamps in a common place.

1. Expand **ComBox Configuration** in the left side menu tree.
2. Click **Events** in the left side menu.

3. Select **Faults and Warnings** in System Event Type.

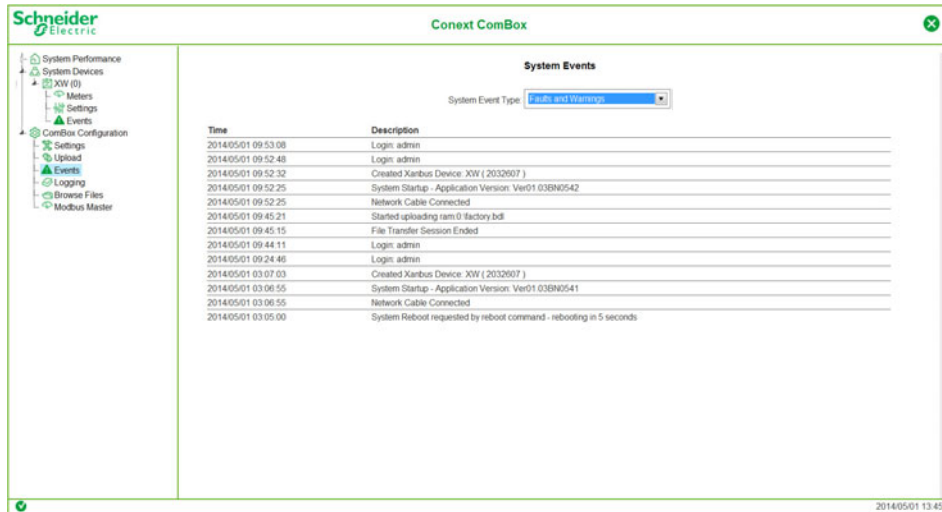

Browsing Event and Fault Log Files

1. Expand **ComBox Configuration** in the left side menu tree.
2. Click **Browse Files** in the left side menu.
3. In the Data Source drop-down, select **Energy and Event Logs**.
4. Click the root folder to expand the file tree.

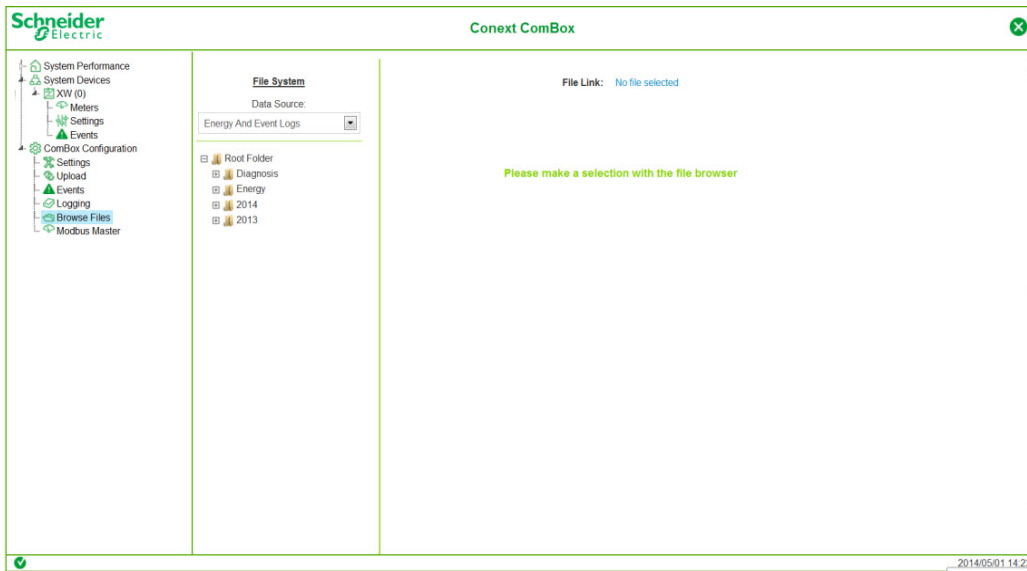

The root folder contains the following folders:

- A Diagnosis folder, which contains diagnostic data for use by Schneider Electric only,
- An Energy folder, which contains energy log data for the attached Xanbus devices.

- One or more yearly folders containing event and fault log data.
5. Under the root folder, click one of the year folders to view event and fault log data for a particular year, for example, 2013.
 6. Click to expand the month within the selected year, for example, 06.
The files in the month folder are in the following format: *yyymmdd.evt.txt* (event log files) and *yyyymmdd.fl.txt* (fault log files).
 7. Left click a log file (for example, *20130601.evt.txt*, the event log for 1 June 2013). The log file displays in the right-hand preview pane of the System Log Browser.
 8. To open the log file in a separate browser window, left-click the File Link at the top of the preview pane.
 9. To save the log file to a local copy on your computer, right-click the File link at the top of the preview pane and select **Save link as...**

Browsing Energy Log Files

1. Expand **ComBox Configuration** in the left side menu tree.
2. Click **Browse Files** in the left side menu.
3. In the Data Source drop-down, select **Energy and Event Logs**.
4. Click the root folder to expand the file tree.
5. Click the **Energy** folder to expand the Energy sub-directory.

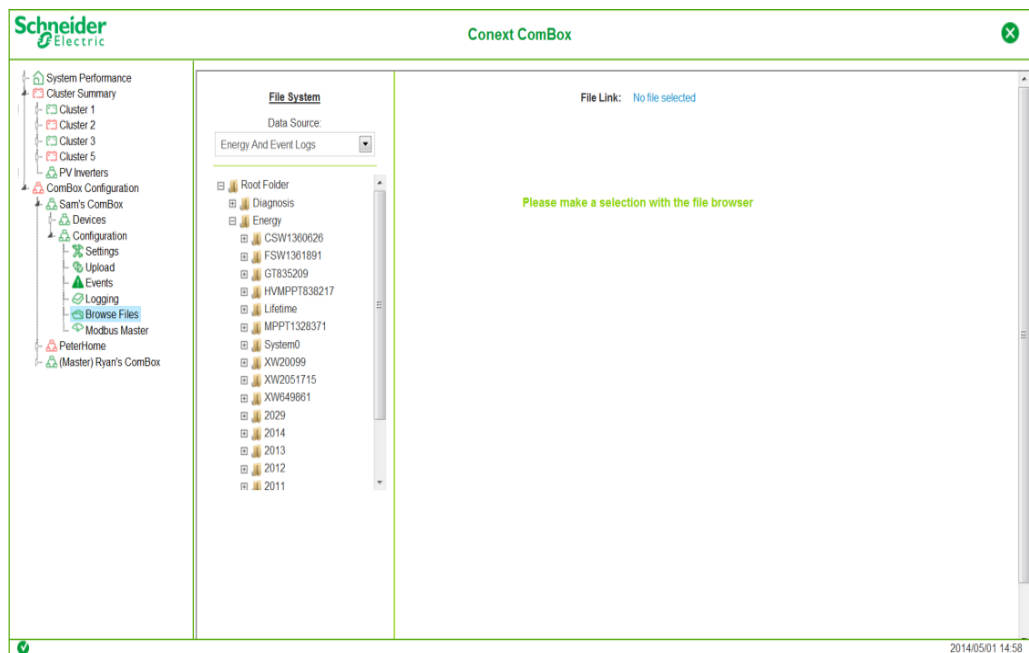

6. Click the year sub-directory to review data for the specified year, for example, 2013.

Energy data is arranged into file groups arranged into directories by device type and identifier, for example:

GT1788172: GT device with ID 1788172

HVMPPT842343: MPPT-80 device with unique identifier 842343, etc.

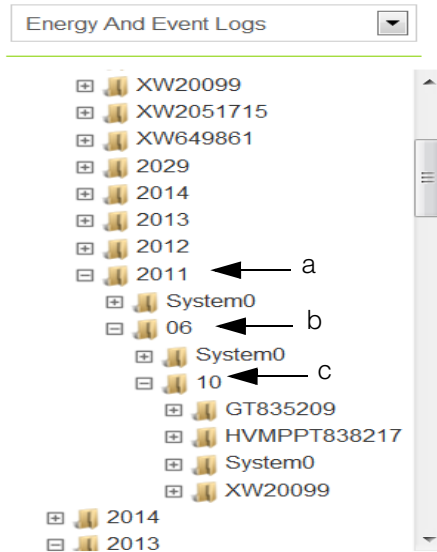

a - Yearly energy data by device type

b - Monthly energy data by device type

c - Daily energy data by device type

Within each time period (year, month, day) directory, if applicable:

- System data is stored in the System0 directories.
- Conext XW+ data is stored in the XW<deviceid> directories
- MPPT-60 energy data is stored in the MPPT<deviceid> directories
- MPPT-80 energy data is stored in the HVMPPT<deviceid> directories
- Grid Tie energy data is stored in the GT<deviceid> directories
- Conext SW data is stored in the CSW<deviceid> directories

In each device sub-directory, the data logs are arranged by port type on the device.

For example, the AC1Out.log file for the XW device type contains energy log data for the AC1 output port (energy to grid).

7. Left-click the .log file to display the energy data in the System Log Browser preview pane.

The System Log Browser preview pane displays the energy (in WattHours) generated on the XW AC1 output for each hour of the day.

8. To open the log file in a separate browser window, left-click the File Link at the top of the preview pane.
9. To save the log file to a local copy on your computer, right-click the File link at the top of the preview pane and select **Save link as...**

Troubleshooting

Problem	Symptom	Solution
Device Discovery Tool cannot find the Conext ComBox.	The Conext ComBox is not listed in the results list from the search.	<p>Check to see if the Power indicator is on.</p> <p>Check all Conext ComBox connections to make sure they are secure.</p> <p>Check the configuration settings. See “Changing Conext ComBox Settings” on page 3–13.</p> <p>Check that there are no faults with the Ethernet cables.</p>
Unexpected behavior in the web user interface.	For example, the Loading in progress message continues for an extended period.	<p>An upgrade may have been applied to the Conext ComBox.</p> <p>Clear your web browser cache. See “Clearing a web browser’s cache” on page 3–43.</p>
Firmware upgrade not successful.	Status light is on, and there is a message in the Upload screen.	<p>There may have been a communication event. Restart the upgrade process.</p> <p>Clear the Conext ComBox internal memory. See “Clearing Conext ComBox Internal Firmware Memory” on page 3–42.</p>
Status light is flashing.		If a firmware upgrade is in progress, wait for it to finish. The Status light will turn off on completion.
Xanbus overload	<p>All devices on the network do not appear in the web user interface.</p> <p>Logged data is random.</p>	The network may exceed traffic limits for the Conext ComBox. The maximum number of devices for the Conext ComBox network is 20.
Conext ComBox does not boot up.	Conext ComBox startup process does not complete.	Reset the Conext ComBox. See “Resetting the Conext ComBox to Factory Settings” on page 3–35



Managing Data Logs

Data logging is an integral function of the Conext ComBox. Data logs record vital information about the electrical system including information about devices in the Xanbus network. Information such as energy consumption, battery charging status, grid energy output, generator output, and system fault detections cannot be displayed in a useful manner without taking data out of data logs. There are two types of data logs - Events and custom Logs.

Events Log

The Conext ComBox records its own device events as well as system-wide faults and warnings that have been detected. You can display this information by accessing the Events log.

To access the Events Log:

1. In the menu tree, click the arrow to the left of  ComBox Configuration to expand the menu.
2. Click  Events from this menu.

A System Events screen, similar to the example shown below, displays.

System Events					
System Event Type: <i>Faults and Warnings</i> ▼					
Time	Action	Device	ID	Code	Description
2013/05/05 01:02:12	Set	CSW4024	1252897	F72	Check AC Associations
2013/05/05 01:01:58	Set	XW SCP	185997	W257	New device detected. Check device settings.

By default, the **System Event Type** displays **Faults and Warnings** detected within the system. This includes each device that reported a fault, the time it occurred, and a brief description.

3. Click the System Event Type drop-down button to select **Events**.



The **System Event Type** displays a log of events recorded by the Conext ComBox device such as Login and Logout events.

System Events	
System Event Type: <i>Events</i> ▼	
Time	Description
2013/05/07 09:31:00	Login: admin
2013/05/07 08:05:03	Logout: admin
2013/05/07 07:35:08	Login: admin
2013/05/07 07:34:26	Login: admin

Custom Logs

The Conext ComBox records custom data logs and stores them in the SD card inserted in the Micro-SD port. When the SD card is inserted, you can display this information by clicking the Logging button.

To access the custom Logging information:

1. In the menu tree, click the arrow to the left of  ComBox Configuration to expand the menu.
2. Click  Logging from the menu.

A screen similar to the example shown below appears.

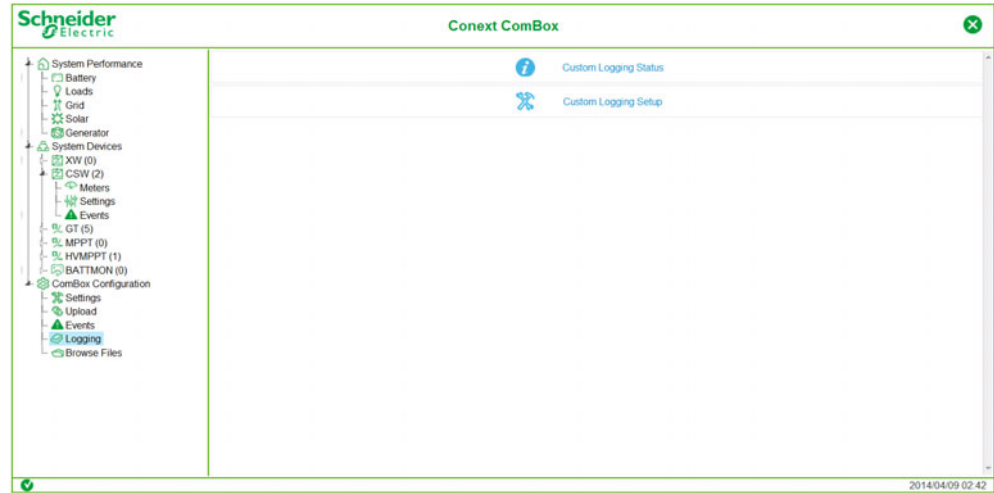

3. Click **Custom Logging Status** to display logging information. If no SD card is inserted or the card is faulty, the error message “No SD Card Detected” will appear.

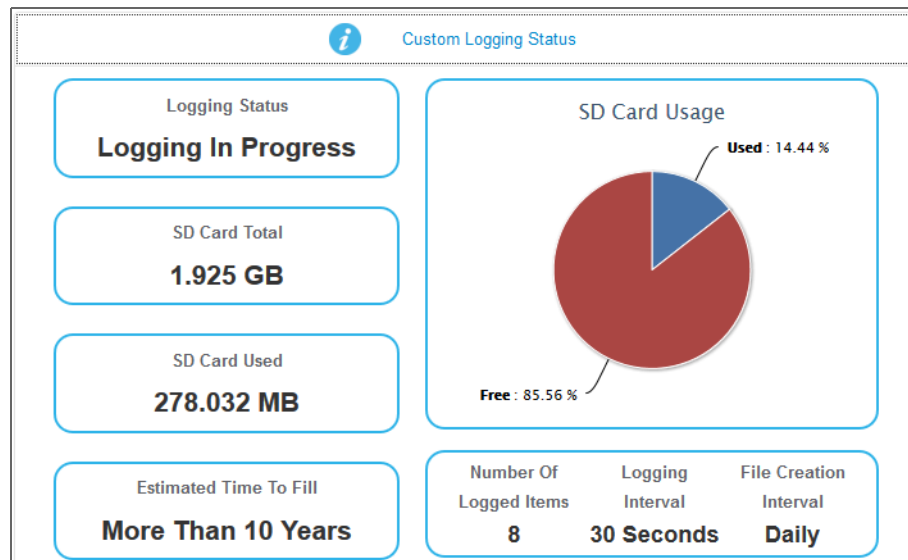

The **Custom Logging Status** displays current information about the Micro-SD card. It displays logging status, the number of logged items, and the frequency of logging and file creation.

4. Click **Custom Logging Setup** to display the settings for logging.

Log	Device	Parameter
1. <input checked="" type="checkbox"/>	AGS (0)	Auto Generator Action
2. <input checked="" type="checkbox"/>	BATTMON (0)	Battery Capacity Remaining
3. <input checked="" type="checkbox"/>	HVMPPT (0)	Auxiliary Output Off Reason
4. <input checked="" type="checkbox"/>	XW (1)	Auxiliary Output Off Reason
5. <input checked="" type="checkbox"/>	MPPT (1)	Auxiliary Output Off Reason
6. <input checked="" type="checkbox"/>	BATTMON (0)	Battery State Of Charge
7. <input checked="" type="checkbox"/>	System	Load Power

The **Custom Logging Setup** allows you to enable and disable logging. You can change logging intervals and choose devices and the associated events that get recorded in the logs. Currently, you can record up to 20 parameters.

Accessing and Downloading Log Files

Log files are saved internally using onboard memory and externally using a Micro-SD card. The Conext ComBox web user interface allows you to browse through log files within a simple file system.

To access the log files:

1. In the menu tree, click the arrow to the left of ComBox Configuration to expand the menu.
2. Click Browse Files in the left side menu.

You will see a screen similar to the following example.

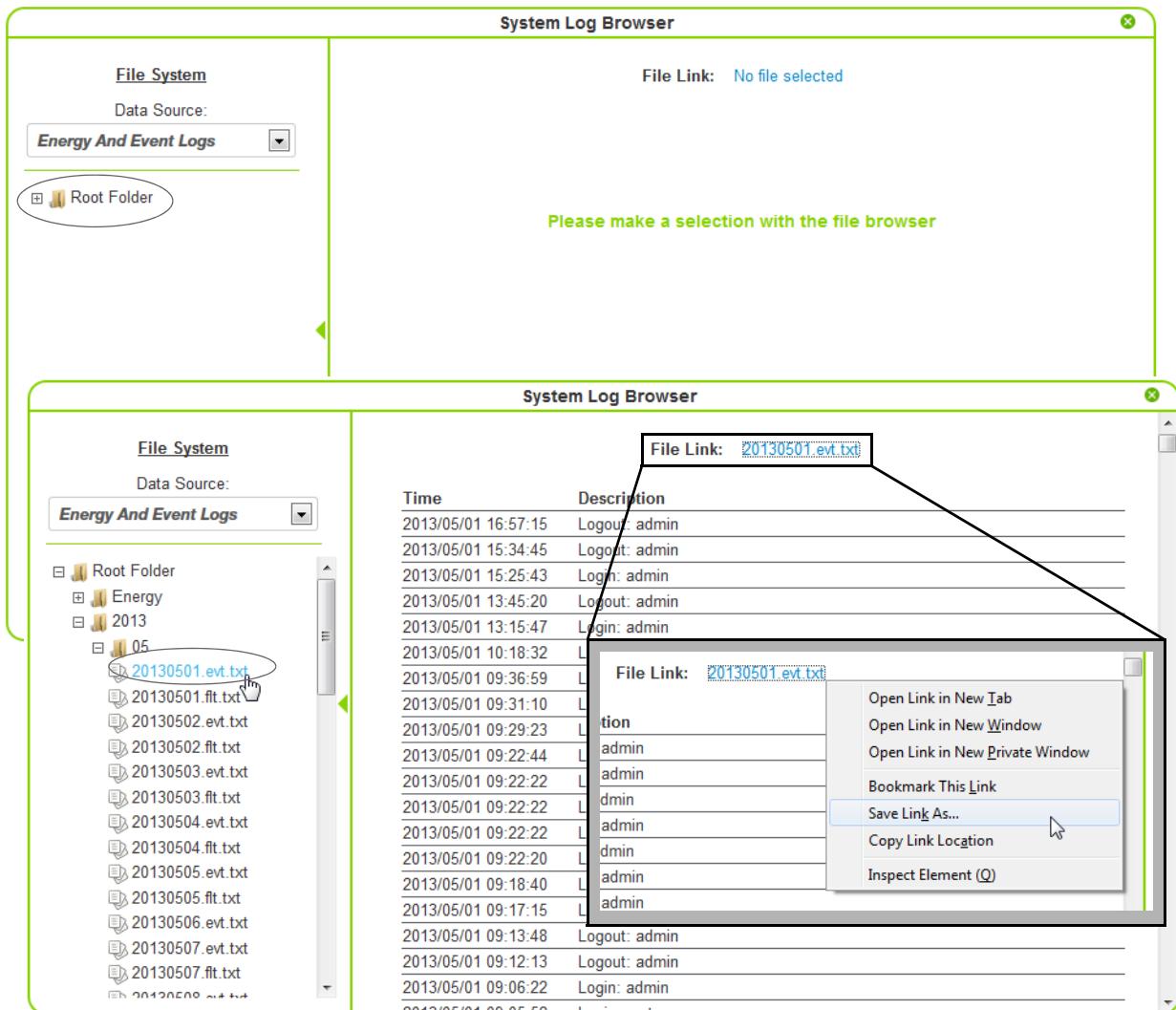

There are two data sources: **Energy And Event Logs** and **Custom Data Logs**. The energy and event logs are stored internally in the Conext ComBox memory and the custom data logs are stored in an external Micro-SD card.

Go through the folders on the left side of the screen to search for log files. The folders represent device names and are organized by year and the numerical month. Each log can be displayed on the main screen. If the file cannot be displayed, a message similar to the one below will advise.

*This file type cannot be displayed,
please right-click the file link to save this file to disk.*

The logs can be viewed on the right-hand panel of the main screen by left-clicking on individual logs.

To download the logs to a hard drive or another storage device, right-click the File Link on top of the main screen, and select Save Link As to save the log to a location.

A

Specifications

Appendix A contains the electrical, mechanical, and environmental specifications for the Conext ComBox Communication and Monitoring Device.

Note: All specifications are subject to change without notice.

Electrical Specifications

Communication Interfaces

Xanbus	Connector: 2 x RJ45 Products Supported: Conext XW+, SW, TX, MPPT 60 150, MPPT 80 600, AGS, SCP - for details on specific Schneider Electric products supported see "Schneider Electric Products that work with the Conext ComBox"
Ethernet	Connector: 1 x RJ45, 10/100 MBPS Server: FTP, Web, Modbus TCP/IP Client: SMTP, SNTP, Auto discovery: DPWS
RS 485	Modbus (1 x Connector: Screw 5-terminal, 16-24AWG, 2-wire serial, 19200 bps) Products Supported: Conext RL, TL, and CL inverters, PM800 Series power meter.

Data Interfaces

USB 2.0-Host	Connector: USB-A, Protocols: MSD
USB 2.0-Device	Connector: USB-mini B, Protocols: CDC, MSD
Data transfer interfaces	USB Host, USB Device, Micro-SD Card
User Interface	Status indicator LEDs on Conext ComBox Web-server pages for Configuration and Monitoring functions

Power Supply (SELV on all sources)

Power Consumption	2 W average / 10 W peak
AC/DC adapter (supplied) ^a	Input: 100-240V AC, 50-60Hz, 0.6A, Output: 12V DC, 1.5A, 5.5mm outer, 2.1mm center-positive jack
Xanbus	When connected to Conext XW+ / SW or MPPT 80 600 providing 15V DC, 200mA min
24V on RS 485 Modbus connector	24V DC, 1A max input only through pins 4 and 5

a. When ordering a replacement, reference PN: 0J-921-0023-Z.

Memory

Internal	96 MB Flash
External	Micro-SD Card (Connector: uSD push-push, up to 2 GB, Class 2 or better recommended)

General Specifications

Weight (device only)	250 g (0.6 lb)
Dimensions (device only) (W × H × D)	6.7 × 4.5 × 2.1 inches (169 × 114 × 54 mm)
Shipping package dimensions (includes device, CD, cables, adapters, connectors, screws, Quick Start Guide)	12.6 × 9.6 × 3.1 inches (320 × 245 × 80 mm)
Shipping package weight	2 kg (4.5 lb)
Housing/Mounting system	ABS Plastic DIN rail: 35 mm top hat Wall mount: 2 screws
IP rating / Mounting Location	IP 20, NEMA 1, Indoor only
Status Display	5 x LEDs
Temperature	Operating: -4 to 122 °F (-20 to 50 °C) Storage: -40 to 185 °F (-40 to 85 °C) Maximum case temperature: 140 °F (60 °C)
Humidity	Operating: < 95%, non-condensing Storage: < 95%

Features

Programmable dry contact relay	Screw 3-terminal, 16-24 AWG, NC-Com-NO, Form: Class 2, 24 V DC, 4 A max SELV input only.
Graphical user interface	Internet Browser, Android Tablet App
Remote firmware upgrades	Yes (ComBox and connected Xanbus devices)
Custom Data logger	Yes (requires Micro-SD card)
Max. number of Xanbus devices	Up to 20 (depending on the device type)

Regulatory Approvals

EMC immunity	EN61000-6-1
EMC emissions	EN61000-6-3, FCC Part 15 Class B, Ind. Canada ICES-003 Class B
Substances / environmental	RoHS



Schneider Electric Products that work with the Conext ComBox

- Conext XW+ Inverter / Chargers:
 - Conext XW+ 7048 E Product No. 865-1040
 - Conext XW+ 8548 E Product No. 865-1035
 - Conext XW+ 5548 NA Product No. 865-1005
 - Conext XW+ 6848 NA Product No. 865-1000-01
- Conext SW Inverter / Chargers:
 - SW 2524 120 Product No. 865-2524
 - SW 4024 120 Product No. 865-4024
 - SW 2524 230 Product No. 865-2524-61
 - SW 4024 230 Product No. 865-4024-61
- Conext TX Grid-Tie Solar Inverter (N. America):
 - TX 2800 Product No. 878-2801
 - TX 3300 Product No. 878-3301
 - TX 3800 Product No. 878-3801
 - TX 5000 Product No. 878-5001
- Grid-Tie Series AUS Solar Inverter:
 - Grid-Tie 2.8 Product No. 864-1030
 - Grid-Tie 5.0 Product No. 864-1039-01
- Conext MPPT 60 150 Solar Charge Controller: Product No. 865-1030-1
- Conext MPPT 80 600 Solar Charge Controller: Product No. 865-1032
- Conext System Control Panel (SCP): Product No. 865-1050
- Conext Automatic Generator Start (AGS): Product No. 865-1060
- Conext Battery Monitor: Product No. 865-1081-01

Physical Dimensions

Front View

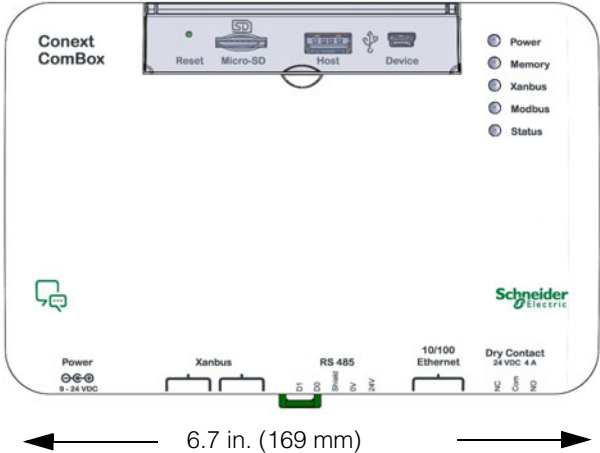

Side View

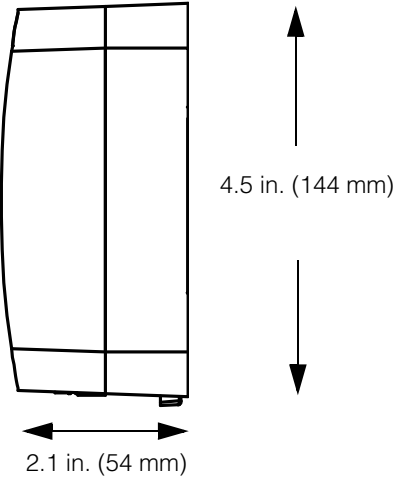

Bottom View

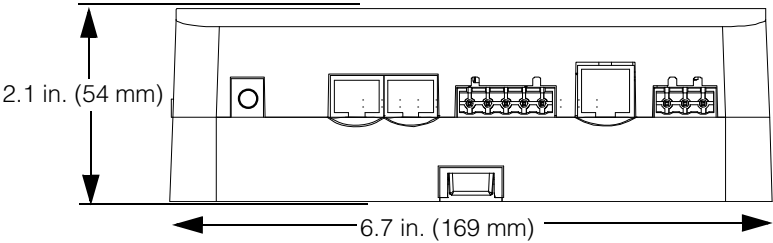

Back View

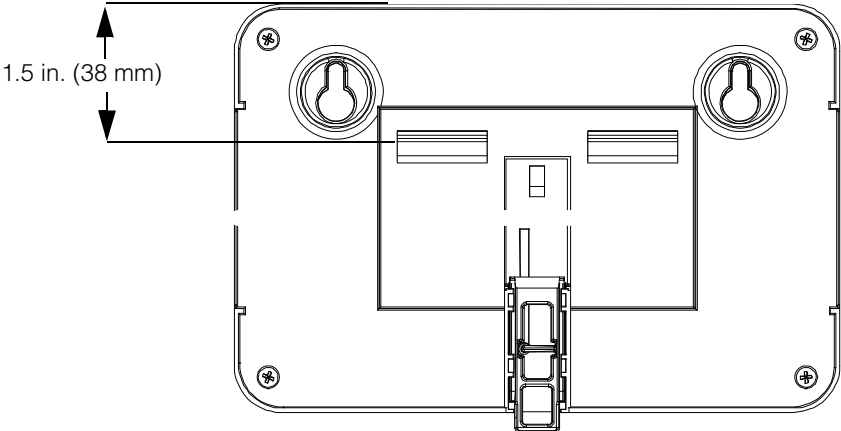

Schneider Electric

www.schneider-electric.com

For other country details please contact your local Schneider Electric Sales Representative or visit the Schneider Electric website at:

<http://www.sesolar.com/where-to-buy/>