

OutBack

POWER™

member of The  Group™



EnergyCell Battery

Owner's Manual



About OutBack Power Technologies

OutBack Power Technologies is a leader in advanced energy conversion technology. OutBack products include true sine wave inverter/chargers, maximum power point tracking charge controllers, and system communication components, as well as circuit breakers, batteries, accessories, and assembled systems.

Audience

This manual is intended for use by anyone required to install and operate this battery. Be sure to review this manual carefully to identify any potential safety risks before proceeding. The owner must be familiar with all the features and functions of this battery before proceeding. Failure to install or use this battery as instructed in this manual can result in damage to the battery that may not be covered under the limited warranty.

Grid/Hybrid™

As a leader in off-grid energy systems designed around energy storage, OutBack Power is an innovator in Grid/Hybrid system technology, providing the best of both worlds: grid-tied system savings during normal or daylight operation, and off-grid independence during peak energy times or in the event of a power outage or an emergency. Grid/Hybrid systems have the intelligence, agility and interoperability to operate in multiple energy modes quickly, efficiently, and seamlessly, in order to deliver clean, continuous and reliable power to residential and commercial users while maintaining grid stability.

Contact Information

Address:	Corporate Headquarters 17825 – 59 th Avenue N.E. Suite B Arlington, WA 98223 USA	European Office Hansastraße 8 D-91126 Schwabach, Germany
Telephone:	+1.360.435.6030 +1.360.618.4363 (Technical Support) +1.360.435.6019 (Fax)	+49.9122.79889.0 +49.9122.79889.21 (Fax)
Email:	Support@outbackpower.com	
Website:	www.outbackpower.com	

Disclaimer

UNLESS SPECIFICALLY AGREED TO IN WRITING, OUTBACK POWER TECHNOLOGIES:

- (a) MAKES NO WARRANTY AS TO THE ACCURACY, SUFFICIENCY OR SUITABILITY OF ANY TECHNICAL OR OTHER INFORMATION PROVIDED IN ITS MANUALS OR OTHER DOCUMENTATION.
- (b) ASSUMES NO RESPONSIBILITY OR LIABILITY FOR LOSS OR DAMAGE, WHETHER DIRECT, INDIRECT, CONSEQUENTIAL OR INCIDENTAL, WHICH MIGHT ARISE OUT OF THE USE OF SUCH INFORMATION. THE USE OF ANY SUCH INFORMATION WILL BE ENTIRELY AT THE USER'S RISK.

Information included in this manual is subject to change without notice.

Notice of Copyright

EnergyCell Battery Owner's Manual © December 2013 by OutBack Power Technologies. All Rights Reserved.

Trademarks

OutBack Power is a registered trademark of OutBack Power Technologies. The ALPHA logo and the phrase "member of the Alpha Group" are trademarks owned and used by Alpha Technologies Inc. These trademarks may be registered in the United States and other countries.

Date and Revision

December 2013, Revision C

Part Number

900-0127-01-00 Rev C



Table of Contents

Important Safety Instructions	4
Additional Resources	4
EnergyCell Batteries	5
Welcome to OutBack Power Systems	5
EnergyCell GH Front Terminal	5
EnergyCell RE	6
Top Terminal.....	6
Front Terminal	6
Materials Required	7
Tools.....	7
Accessories	7
Storage and Environment Requirements.....	7
Temperatures	7
Self-Discharge	7
Capacity	8
State of Charge.....	8
System Layout	9
Battery Configurations	9
DC Wiring	11
Commissioning	13
Charging (EnergyCell GH)	13
Float Charge	13
Freshening Charge.....	14
Charging (EnergyCell RE).....	14
Bulk Stage	14
Absorption Stage	14
Float Stage.....	15
Freshening Charge	15
Notes on EnergyCell RE Charging	15
Temperature Compensation.....	15
Remote Temperature Sensor	16
Improper Use	16
Troubleshooting and Maintenance	17
Periodic Evaluation	18
Specifications	19

Important Safety Instructions

READ AND SAVE THESE INSTRUCTIONS!

This manual contains important safety instructions for the EnergyCell battery. These instructions are in addition to the safety instructions published for use with all OutBack products. Read all instructions and cautionary markings on the EnergyCell battery and on any accessories or additional equipment included in the installation. Failure to follow these instructions could result in severe shock or possible electrocution. Use extreme caution at all times to prevent accidents.



WARNING: Personal Injury

- Some batteries can weigh in excess of 100 lb (45 kg). Use safe lifting techniques when lifting this equipment as prescribed by the Occupational Safety and Health Association (OSHA) or other local codes. Lifting machinery may be recommended as necessary.
- Wear appropriate protective equipment when working with batteries, including eye or face protection, acid-resistant gloves, an apron, and other items.
- Wash hands after any contact with the lead terminals or battery electrolyte.



WARNING: Explosion, Electrocution, or Fire Hazard

- Ensure clearance requirements are strictly enforced around the batteries.
- Ensure the area around the batteries is well ventilated and clean of debris.
- Never smoke, or allow a spark or flame near, the batteries.
- Always use insulated tools. Avoid dropping tools onto batteries or other electrical parts.
- Keep plenty of fresh water and soap nearby in case battery acid contacts skin, clothing, or eyes.
- Wear complete eye and clothing protection when working with batteries. Avoid touching bare skin or eyes while working near batteries.
- If battery acid contacts skin or clothing, wash immediately with soap and water. If acid enters the eye, immediately flood it with running cold water for at least 20 minutes and get medical attention as soon as possible.
- Never charge a frozen battery.
- Insulate batteries as appropriate against freezing temperatures. A discharged battery will freeze more easily than a charged one.
- If a battery must be removed, always remove the grounded terminal from the battery first. Make sure all devices are de-energized or disconnected to avoid causing a spark.
- Do not perform any servicing other than that specified in the installation instructions unless qualified to do so and have been instructed to do so by OutBack Technical Support personnel.

Additional Resources

These references may be used when installing this equipment. Depending on the nature of the installation, it may be highly recommended to consult these resources.

Institute of Electrical and Electronics Engineers (IEEE) guidelines: IEEE 450, IEEE 484, IEEE 1184, IEEE 1187, IEEE 1188, IEEE 1189, IEEE 1491, IEEE 1578, IEEE 1635, and IEEE 1657 (various guidelines for design, installation, maintenance, monitoring, and safety of battery systems)



EnergyCell Batteries

Welcome to OutBack Power Systems

Thank you for purchasing the OutBack EnergyCell battery. EnergyCell is a series of absorbed glass-mat (AGM) batteries with a valve-regulated lead-acid (VRLA) design. They are designed to provide long, reliable service with minimal maintenance. Several versions are available, including front-terminal and top-terminal designs. All have high recharge efficiency and a compact footprint for higher energy density. All have a thermally welded case-to-cover bond to eliminate leakage, all are 100% recyclable, and all are UL-recognized components.

EnergyCell GH Front Terminal

The EnergyCell GH (Grid/Hybrid) Series uses pure lead plates. It is intended to receive continuous float charging under normal conditions when utility power is present.

- Intended for use with Grid/Hybrid™ systems, particularly grid-interactive or grid-backup (float service) applications with occasional interruptions but minimal cycling
- Pure lead plates for long float service life in battery backup applications
- Extended shelf life

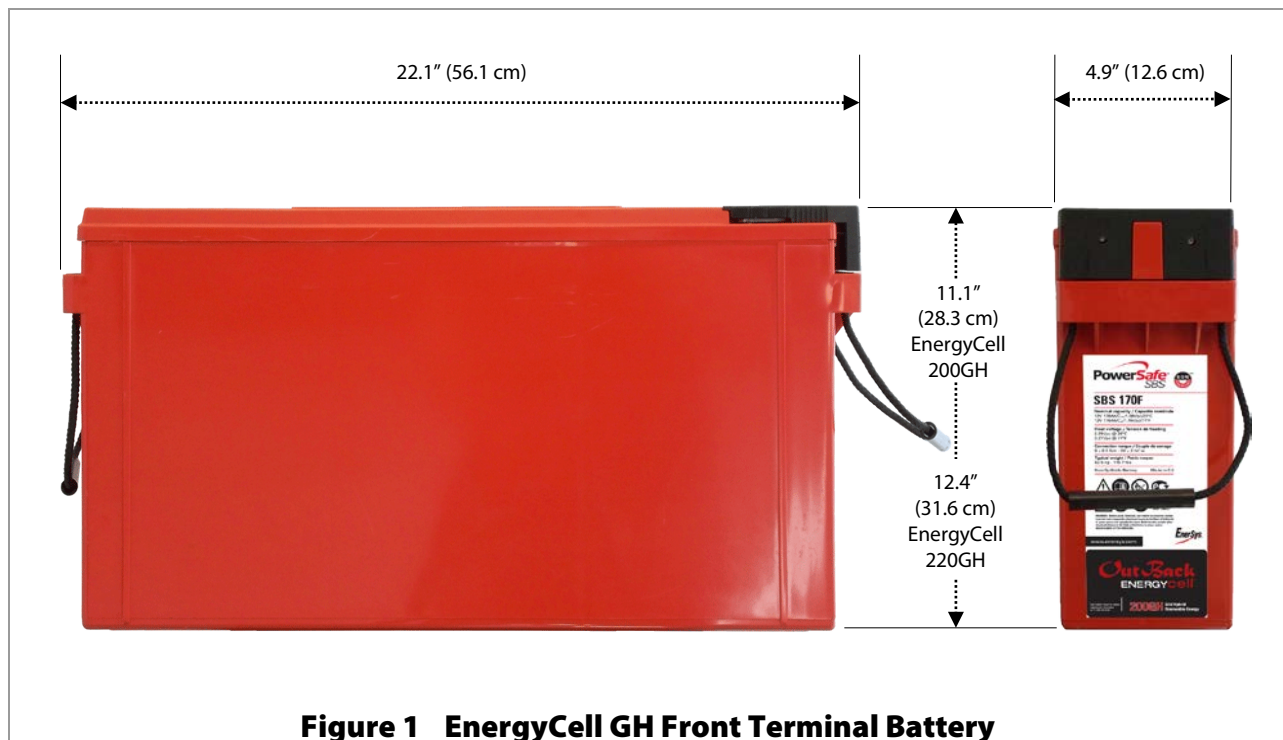

Installation and Operation

EnergyCell RE

The EnergyCell RE (Renewable Energy) Series uses pasted lead-calcium-tin plates. It is designed for regular discharge/charge cycles. The EnergyCell RE is available in both top-terminal and front-terminal designs.

- Intended for use in backup, off-grid, and renewable energy (RE) sites with OutBack inverters, charge controllers, and other devices that require the use of deep-cycle batteries
- Lead-calcium-tin alloy plates for long life in both cycling and float applications
- High-density pasted plates for high cycle life

Top Terminal

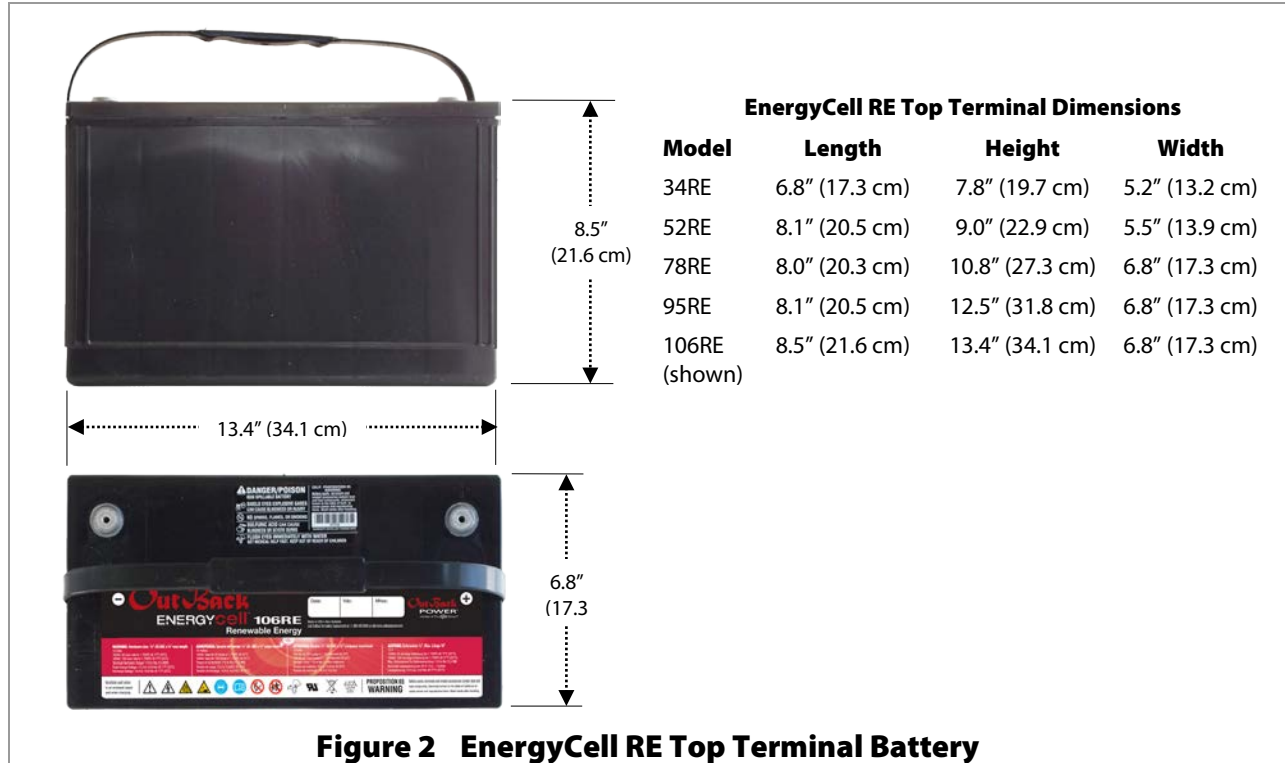

Figure 2 EnergyCell RE Top Terminal Battery

Front Terminal

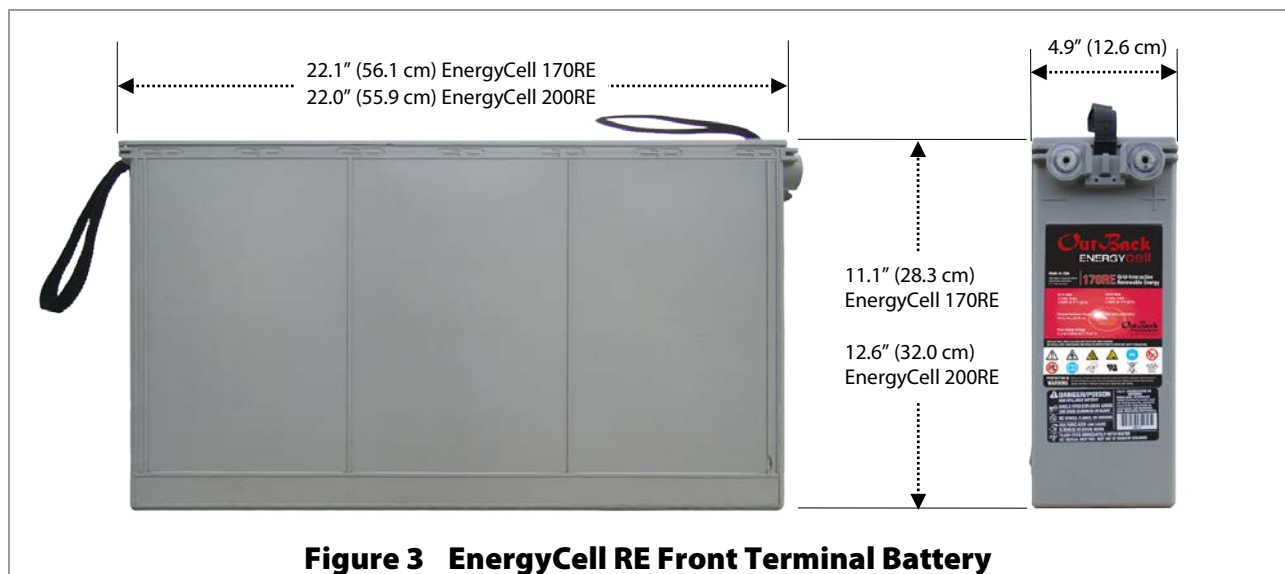

Figure 3 EnergyCell RE Front Terminal Battery

Materials Required

Tools (use insulated tools only)

- Torque wrenches
- Voltmeter

Accessories

- Interconnect bar (provided with front terminal batteries only)
- Terminal cover (provided with front terminal batteries only)
- Hardware kit
- Interconnect cables as needed



CAUTION: Fire Hazard

Install properly sized battery cabling and interconnect cables. The cable ampacity must meet the needs of the system, including temperature, deratings, and any other code concerns.

Storage and Environment Requirements

Temperatures

- EnergyCell batteries should not be operated in an environment where the average ambient temperature exceeds 85°F (27°C). The peak temperature of the operating environment should not exceed 110°F (43°C) for a period of more than 24 hours. High operating temperatures will shorten a battery's life (see page 8).
- Do not allow batteries to freeze, as this will damage them and could result in leakage.
- Do not expose batteries to temperature variations of more than 5°F (3°C). This leads to voltage imbalance between multiple batteries (or between battery cells if there is a temperature differential).
- Batteries should be stored in a cool, dry location. Place them in service as soon as possible. The best storage temperature is 77°F (25°C), but a range of 60°F (16°C) to 80°F (27°C) is acceptable.

Self-Discharge

All EnergyCell batteries will discharge over time once charged, even in storage. Higher storage temperatures increase the rate of self-discharge. The EnergyCell GH has a longer shelf life than other VRLA batteries, including the EnergyCell RE. At room temperature (77°F or 25°C), the EnergyCell GH has a shelf life of 18 months before self-discharging to unacceptable levels. Figure 4 shows the rate of EnergyCell GH self-discharge at various temperatures.

Fully charged, the natural ("rest") voltage of all EnergyCell batteries is approximately 12.8 Vdc. A battery should have a freshening charge (see pages 14 and 15) if its rest voltage is below 12.5 Vdc per battery (2.08 Vdc per cell). A battery should not be used if its rest voltage is 12.0 Vdc or lower upon delivery. Contact the vendor upon receiving a battery in this state.

No EnergyCell should **ever** be permitted to self-discharge below 70% state of charge (SoC). Such a condition is highly detrimental and will shorten battery life. (This situation is not the same as discharging to 70% SoC or lower under load. See page 8.)

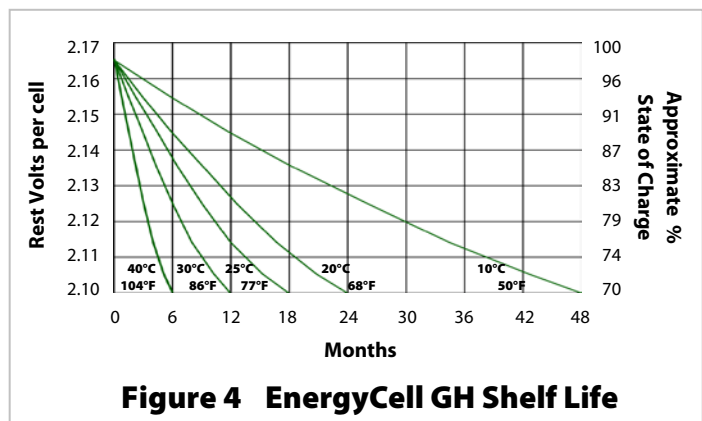

Figure 4 EnergyCell GH Shelf Life

Installation and Operation

Storing EnergyCell GH Batteries

The EnergyCell GH must be kept in storage no longer than the shelf life indicated in Figure 4 for a particular temperature. At the end of this time it must be given a freshening charge. That is, a battery stored at 104°F (40°C) should be stored no longer than six months, while it can be stored up to 48 months at 50°F (10°C) without a charge.

Stored batteries should be checked for open-circuit voltage at intervals. Any time the battery voltage is less than 2.10 volts per cell (12.6 volts per battery), it should be given a freshening charge regardless of the storage time.

At 104°F (40°C), the EnergyCell GH voltage should be checked every 2 months. At 86°F (30°C), the interval is 3 months. At 77° to 68°F (25° to 20°C) the interval is 4 months. At temperatures lower than 59°F (15°C), the voltage only needs to be checked every 6 months.

Storing EnergyCell RE Batteries

The EnergyCell RE must be given a freshening charge every six months when stored at 77°F (25°C). The charge should be every three months if stored at temperatures of up to 92°F (33°C). If stored in higher temperatures, the charge should be every month.

Capacity

Battery capacity is given in ampere-hours (amp-hours). This is a current draw which is multiplied by the duration of current flow. A draw of X amperes for Y hours equals an accumulation of XY amp-hours.

Because the battery's chemical reaction constantly releases energy, it tends to replenish its own charge to a minor degree. Smaller loads will deplete the batteries less than larger loads because of this constant replenishment. This means that effectively the battery has more capacity under lighter loads.

For example, if the EnergyCell 170RE is discharged at the 48-hour rate to a voltage of 1.75 volts per cell (a load expected to effectively drain 100% of its capacity in 48 hours), it will be measured to have 163.9 amp-hours. However, at the 4-hour rate, a heavier load, only 120.6 amp-hours will be measured. For discharge rates and amp-hours of all EnergyCell batteries, see the tables on page 20.

The EnergyCell models are named after their capacity at the 100-hour rate when discharged to 1.75 volts per cell.

State of Charge

The EnergyCell SoC can be determined by two methods. One is to measure its voltage. This is accurate only if the batteries are left at rest (no charging or loads) for 24 hours at room temperature (77°F or 25°C). **If these conditions are not met, then voltage checks may not yield usable results.** If they are met, then on average, a battery at 12.8 Vdc will be at 100% SoC. A rest voltage of 12.2 Vdc represents roughly 50% SoC.

The more accurate method is to use a battery monitor such as the OutBack FLEXnet DC. Using a sensor known as a shunt, the monitor observes the current through the battery. It keeps a total of amp-hours lost or gained by the battery and can give accurate SoC readings.

The EnergyCell can be discharged and recharged (cycled) regularly to a level as low as 50% depth of discharge (DoD). This is common in a cycling application such as an off-grid system. However, for optimal battery life, the best practice is to avoid regular discharge below 50%. The battery can be occasionally discharged as low as 80% DoD (20% SoC), as is common in emergency backup systems. However, the best practice is to avoid ever discharging below 80% DoD.

If operated in the recommended range, the EnergyCell will typically have a life of hundreds of cycles. With consistently lighter discharge, the battery may have thousands of cycles. For the anticipated cycle life of a particular model, see the OutBack data sheet for that battery. (The cycle life can be affected by temperature. Figure 5 shows the effect of ambient temperature on typical battery life.)

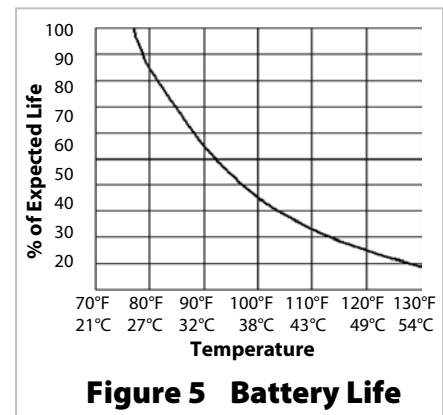

Figure 5 Battery Life

System Layout



CAUTION: Fire Hazard

Failure to ventilate the battery compartment can result in the buildup of hydrogen gas, which is explosive.

- The battery enclosure or room must be well-ventilated. This protects against accidental gas buildup. All EnergyCell batteries are sealed and do not normally emit noticeable amounts of gas. However, in the event of accidental leakage, the enclosure must not allow gas to become concentrated.
- The battery enclosure or room must have adequate lighting. This is necessary to read terminal polarity, identify cable color, and view the physical state of the battery as required.
- The battery should be installed with a minimum 36" (91.4 cm) clearance in front. This allows access for testing, maintenance, and any other reasons.
- If multiple batteries are installed, they should have a minimum of 1/2" (12.7 mm) clearance on either side.

Battery Configurations

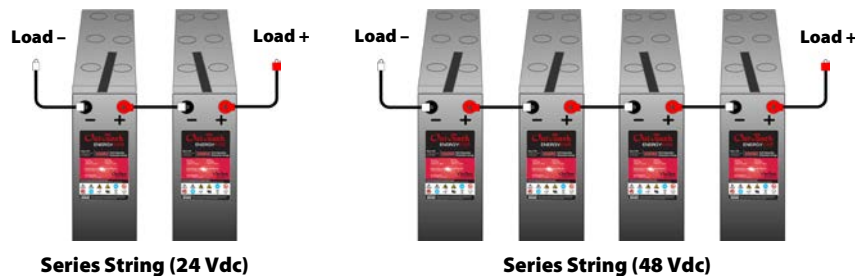

Batteries are placed in series (negative to positive) for additive voltages. Batteries in series are known as a "string". A string of two EnergyCell batteries has a nominal voltage of 24 Vdc and can be used for 24-volt loads. A string of four has a nominal voltage of 48 Vdc. Other voltages are possible. However, batteries in series do not have additive amp-hours. A single string of any voltage (as shown above) has the same amp-hours as a single battery.

When replacing batteries, a new battery should not be placed in series with old batteries. This will cause severe stress and shorten the life of all batteries. All batteries in a string should be replaced at the same time.

Figure 6 Series String Configurations

Batteries are placed in parallel (positive to positive, negative to negative) for additive amp-hour capacity. Three batteries in parallel have three times the amp-hours of a single battery. However, batteries in parallel do not have additive voltages. A single set of batteries in parallel (as shown in this figure) have the same voltage as a single battery.

NOTE: Use caution when designing or building systems with more than three batteries or strings in parallel.

The extra conductors and connections used in larger paralleled systems can lead to unexpected resistances and imbalances between batteries. Without proper precautions, these factors will reduce the system efficiency and shorten the life of all batteries.

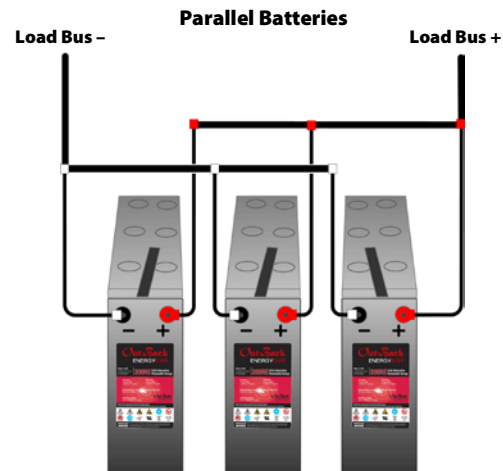

Figure 7 Parallel String Configuration

Installation and Operation

Batteries are placed in both series and parallel for both additive voltage and amp-hour capacity. Series strings placed in parallel have the same nominal voltage as each string. They have the same amp-hour capacity of each string added together. Two parallel strings of two EnergyCell batteries in series have a nominal voltage of 24 Vdc, twice the nominal voltage. They also have double the amp-hour capacity of a single battery. Two parallel strings of four batteries in series have a nominal voltage of 48 Vdc at double the amp-hour capacity of a single battery.

In a series-parallel bank, it is not recommended to connect the load to the positive and negative terminals of a single string. Due to cable resistance, this will tend to put more wear on that string. Instead, it is recommended to use "reverse-return" or "cross-corner" wiring, where the positive cable is connected to the first string and the negative is connected to the last. This will allow current to flow evenly among all strings.

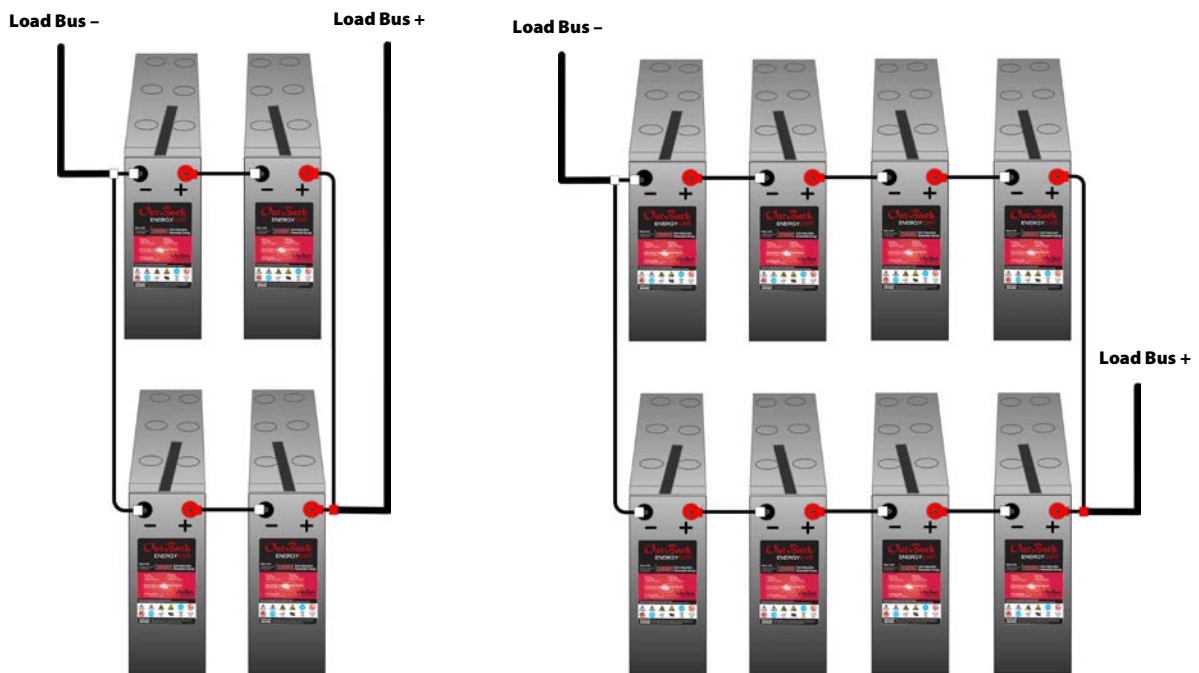

Figure 8 Series/Parallel String Configurations

DC Wiring

	<p>CAUTION: Equipment Damage Never reverse the polarity of the battery cables. Always ensure correct polarity.</p>
	<p>CAUTION: Fire Hazard Always install a circuit breaker or overcurrent device on the DC positive conductor for each device connected to the batteries.</p>
	<p>CAUTION: Fire Hazard Never install extra washers or hardware between the mounting surface and the battery cable lug or interconnect. The decreased surface area can build up heat.</p>

Terminal Hardware

EnergyCell batteries use one of two terminal types: A threaded stud which receives a nut, or a threaded hole which receives a bolt. The terminal type, hardware sizes, and torque requirements may be different between battery models. See Table 4 and Table 5 on page 19 for the requirements of a particular model. However, all terminal hardware is assembled as shown in either Figure 9 or Figure 10.

NOTE: Install the cable lugs (or interconnects) and all other hardware in the order illustrated. The lug or interconnect should be the first item installed. It should make solid contact with the mounting surface. Do not install hardware in a different order than shown.

NOTE: To avoid corrosion, use plated lugs on cable terminations. When multiple cables are terminated, use plated terminal bus bars.

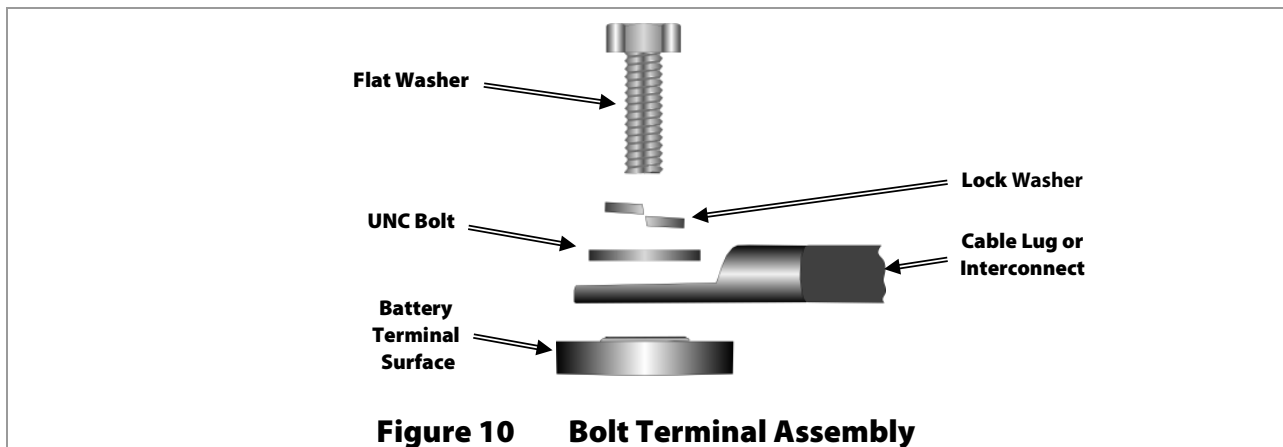
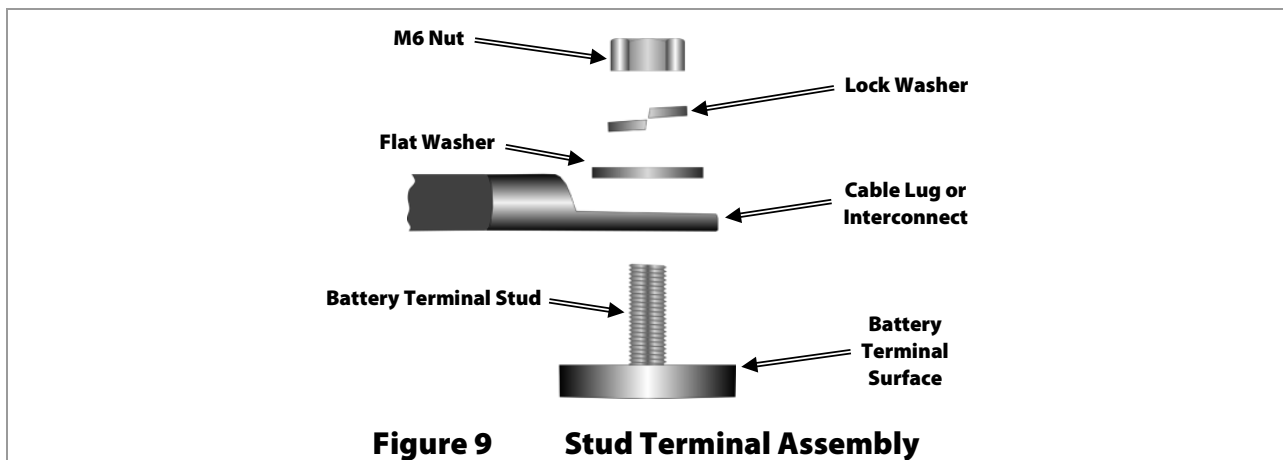

Installation and Operation



To make the DC connections:

1. If installing batteries in a rack or cabinet, always begin with the lowest shelf for stability. Place all batteries with terminals facing to the most accessible side of the rack. If terminal protectors are present, remove and save them.
2. Clean all terminals and contact surfaces.
3. In common configurations, the battery on one end will be the positive (+) output for that string. This battery should be designated ①. Proceeding to the other end, adjacent batteries in that string should be designated ②, ③, and so on.
4. If more than one string is present, designate the first string as A, the second as B, and so on. This should be done regardless of whether the strings are on the same shelf or higher shelves. Number the batteries in subsequent strings just as was done in step 3.
5. Install series connections. If an interconnecting bar was supplied with a front-terminal battery, it should connect from the negative (left) side of battery 1 to the positive (right) side of battery 2 as shown above. Top-terminal batteries require short interconnecting cables to be provided. Tighten interconnect hardware "hand tight" only.
6. Repeat the process as appropriate for batteries 2, 3, and any others in the string. Connect the proper number of batteries in series for the nominal voltage of the load.
7. If multiple series strings will be used, repeat this process for strings B, C, and so on.
8. Install parallel connections. Parallel connections are made from the positive terminal of one battery or string to the positive of the next; negative connections are made similarly. (See Figure 7 on page 9.) External cables or bus bars must be provided. The interconnecting bar included with front-terminal batteries cannot make parallel connections.
9. Use a digital voltmeter (DVM) to confirm the nominal system voltage and polarity. Confirm that no batteries or strings are installed in reverse polarity.
10. Install cables or bus bars for DC loads. Size all conductors as appropriate for the total loads. See the manual for the battery rack or cabinet if necessary.
11. Before making the final battery connection, ensure the main DC disconnect is turned off. If this is not possible, then do not make the final connection within the battery enclosure. Instead, make it at the load or elsewhere in the cable system so that any resulting spark does not occur in the battery enclosure.
12. Once hardware is installed and batteries are properly aligned, torque all connections to the appropriate value for the battery model. (See the requirements on page 19.) Lightly coat the surfaces with battery terminal grease. Reinstall the terminal covers if present.

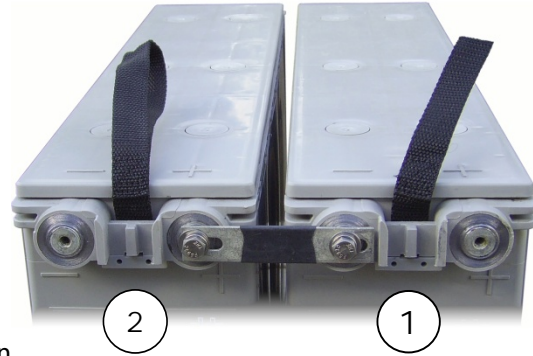

Figure 11 Connecting Batteries



IMPORTANT:

Before using the battery bank, commission the batteries as described on the next page.

Commissioning

Before commissioning batteries:

1. Measure and record inter-battery connection resistances and open circuit voltages. These measurements should be used as a reference for future maintenance requirements.
2. Perform a visual inspection of all terminals, components, and connections.
3. Verify that the charger's set points are adjusted to the correct values for the battery and the application.

To commission batteries before initial use:

1. Send the batteries through a complete charge cycle (see next section) according to these instructions:
 - ~ The batteries should be held at the specified absorption voltage for 24 hours.
 - ~ Following this stage, the batteries should be held at the specified float voltage for three to seven days.
2. Clean all battery terminals to ensure reliable electrical connections.
3. Install a DC load which draws a continuous 25 Adc. This allows the results to be correlated to the specified capacity. The load may be used on either a single battery or a full string.
4. The load test unit wires must be sized correctly. For load testing all wiring should have a minimum ampacity of 150% of the load current.
5. With this load, discharge the batteries until they have reached 10.5 Vdc per battery (1.75 Vdc per cell).
6. Monitor the elapsed time. At the same time, monitor the battery's temperature.
7. Record the temperature at the end of the test. Use the equation below to adjust the results for temperature.

$$M_c = M_r(1 - 0.009 [T - 26.7])$$

where M_r = actual elapsed minutes

T = temperature at end of run time

M_c = minutes corrected for temperature with a baseline of 80°F (26.7°C).

8. Compare M_c with the appropriate value in Table 1. The batteries should deliver greater than 90% of their rated run time.

Table 1 Rated Values for M_c

EnergyCell model	Expected M_c	
	Minutes	Hours
34RE	50.1	< 1
52RE	78.3	1 hr 18 min
78RE	123.8	2 hr 4 min
95RE	139.8	2 hr 20 min
106RE	153.2	2 hr 33 min

EnergyCell model	Expected M_c	
	Minutes	Hours
170RE	300	5
200RE	347	5 hr 47 min
200GH	348	5 hr 48 min
220GH	460	7 hr 40 min

Charging (EnergyCell GH)

EnergyCell GH batteries are usually charged using a constant-voltage or float charger. OutBack inverter/chargers and charge controllers do not have this function as their default setting. They can be made to perform a constant float charge by skipping the absorption stage or setting the absorption voltage equal to the float voltage. Other adjustments may be necessary.

Float Charge

A float charger gradually charges the batteries by maintaining them at a fixed voltage. In backup applications, it is common for this voltage to be maintained continuously by the charger until the batteries are needed. However, if the charger is not in regular operation, the batteries should be given an occasional freshening

Installation and Operation

charge for a minimum of 24 hours. After discharge, the float charge should be applied as soon as possible. It must not be delayed more than 7 days in any case.

The charger should be sized so that the full charge rate is at least 17 Adc per battery string.

The float charger should be set to maintain the batteries at 13.62 Vdc per battery in a string (2.27 volts per cell) at 77°F (25°C). Other temperatures require voltage compensation within a range of 2.21 to 2.29 volts per cell. See Temperature Compensation on page 15.

Freshening Charge

A maintenance or “freshening” charge is given to batteries that have been in storage. The freshening charge must be appropriate to the battery model. All charging should be temperature-compensated (see page 15).

The charge should proceed as described above using a float charger. The voltage should be 13.62 Vdc per battery in a string (2.27 volts per cell).

Charging (EnergyCell RE)

EnergyCell RE batteries are usually charged using a “three-stage” charging cycle: bulk stage, absorption stage, and float stage. Most OutBack chargers follow this algorithm. However, not all chargers are designed or programmed the same way. The settings should be checked and changed to match the recommendations below if necessary. Contact OutBack Technical Support before using other charger types.

Bulk Stage

The bulk stage is a constant-current stage. The charger’s current is maintained at a constant high level. The battery voltage will rise as long as the current continues to flow. Each battery model has a recommended maximum current limit (see Table 6 on page 19) which should not be exceeded. At excessive current rates, the battery’s efficiency of conversion becomes less and it may not become completely charged. The battery may permanently lose capacity over the long term.

The purpose of the bulk stage is to raise the battery to a high voltage (usually referred to as either bulk voltage or absorption voltage). The acceptable voltage range is 14.4 to 14.8 Vdc per battery in a string (2.40 to 2.47 volts per cell). If batteries are in series, this number is multiplied by the number of batteries in the string. This stage typically restores the battery to 85% to 90% SoC, if the charge rate does not exceed the maximum shown on page 19.

Absorption Stage

The absorption stage is a constant-voltage stage. It is established upon reaching the desired voltage in the bulk stage. This causes the charger to begin limiting the current flow to only what is necessary to maintain this voltage. A large amount of current is required to raise the voltage to the absorption level, but less current is required to maintain it there. This requirement will tend to decrease as long as the absorption level is maintained, resulting in a tapering current flow. The amount of absorption current will vary with conditions, but will typically decrease to a very low number. This “tops off the tank”, leaving the battery at 100% SoC.

The battery is considered to be completely full when the following conditions are met: The charge current must taper down to a level of current equal to between 1% and 2% of the total battery amp-hours (while

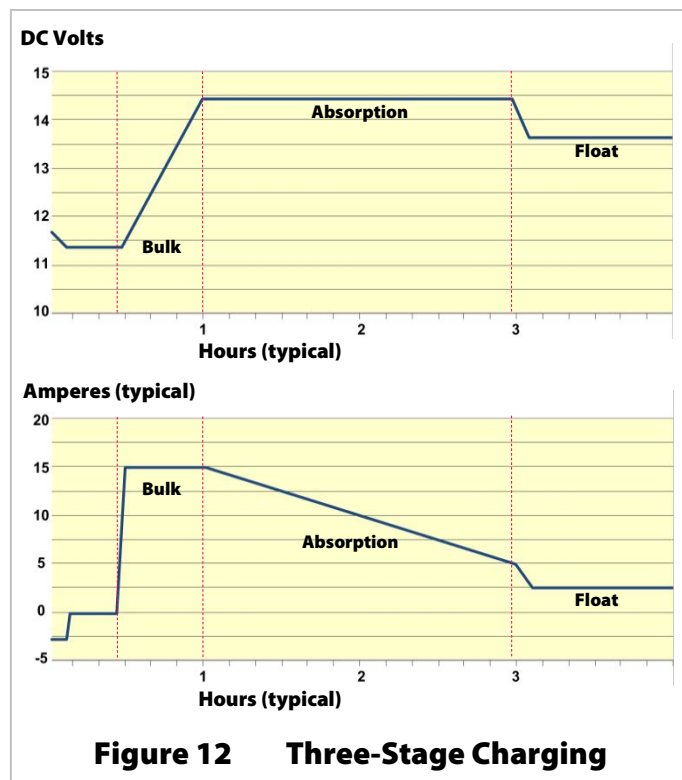

maintaining the absorption voltage). At this point the charger is allowed to exit absorption to the next stage.

Not all chargers measure their absorption stage in amperes. Many chargers maintain absorption for a timed period (often two hours), under the assumption that the current will taper to the desired level during this time. However, if the charger exits absorption and ends the charge before the current has tapered down to the desired level, the battery may not reach 100% SoC. Repeated failure to perform a complete charge will result in decreased battery life. If possible, it is recommended to use a DC ammeter to observe and time the current as it tapers to the proper amperage. The user can then manually set the charger's absorption timer accordingly.

Float Stage

The float stage is a maintenance stage which ensures the battery remains fully charged. Left with no maintenance, the battery will tend to slowly lose its charge. The float stage provides current to counter this self-discharge. As with the absorption stage, float is a constant-voltage stage which supplies only enough current to maintain the designated voltage.

The voltage requirements for float stage are much lower than for bulk and absorption. The voltages per model of EnergyCell RE are listed in Table 6 on page 19. The float stage should provide enough current to maintain the appropriate voltage. If batteries are in series, this number should be multiplied by the number of batteries in the string.

Freshening Charge

A maintenance or "freshening" charge is given to batteries that have been in storage. The freshening charge must be appropriate to the battery model. All charging should be temperature-compensated (see below).

With a three-stage charger, voltages are set as noted in Table 6 on page 19.

If a specialized VRLA charger is available, it should charge EnergyCell RE batteries at 14.4 to 14.8 Vdc continuously for 16 hours before use.

Notes on EnergyCell RE Charging

The current requirements for the absorption and float stages are usually minimal; however, this will vary with conditions, with battery age, and with battery bank size. (Larger banks tend to have higher exit current values for the absorption stage, but they also have higher float current.) Any loads operated by the battery while charging will also impact the requirements for the charger, as the charger must sustain everything.

Not all chargers exit directly to the float stage. Many will enter a quiescent or "silent" period during which the charger is inactive. These chargers will turn on and off to provide periodic maintenance at the float level, rather than continuous maintenance.

Constant-Float Charging

"Constant-float" charging may be used with the EnergyCell RE in backup power applications where the battery bank is rarely discharged. When a discharge occurs, it is critical to recharge the bank as soon as possible afterward. When charged with a constant-float charger, the charger should be set to maintain the batteries at 13.65 Vdc per battery in a string (2.30 volts per cell) at room temperature. The batteries are considered to be fully charged when the cell voltage is maintained at this level and the charge current has dropped to a low level over a long period of time. In constant-float charging, it is critical to compensate the settings for temperature.

The EnergyCell RE is not optimized for constant-float. OutBack recommends using the EnergyCell GH instead.

Temperature Compensation

Battery performance will change when the temperature varies above or below room temperature (77°F or 25°C). Temperature compensation adjusts battery charging to correct for these changes.

When a battery is cooler, its internal resistance goes up and the voltage changes more quickly. This makes it easier for the charger to reach its voltage set points. However, while accomplishing this process, it will not deliver enough current to restore the battery to 100% SoC. As a result, the battery will tend to be undercharged. Conversely, when a battery is warmer, its internal resistance goes down and the voltage changes more slowly.

Installation and Operation

This makes it harder for the charger to reach its voltage set points. It will continue to deliver energy over time until the charging set points are reached. However, this tends to be far more than the battery requires, meaning it will tend to be overcharged. (See Improper Use.)

To compensate for these changes, a charger used with the EnergyCell battery must have its voltages raised by a specified amount for every degree below room temperature. They must be similarly lowered for every degree above room temperature. This factor is multiplied if additional batteries are in series. Failure to compensate for significant temperature changes will result in undercharging or overcharging which will shorten battery life.

EnergyCell GH Required Compensation

The factor is 4 mV per cell (0.024 Vdc or 24 mV per battery) per degree C above or below room temperature (77°F or 25°C).

EnergyCell RE Required Compensation



The factor is 5 mV per cell (0.03 Vdc or 30 mV per battery) per degree C above or below room temperature (77°F or 25°C).

Remote Temperature Sensor

OutBack inverter/chargers and charge controllers are equipped with the Remote Temperature Sensor (RTS) which attaches to the battery and automatically adjusts the charger settings. When the RTS is used, it should be placed on the battery sidewall, as close to the center of the battery (or to the center of the bank) as possible.

The charger determines the RTS compensation factor. Most OutBack chargers are preset to a compensation of 5 mV per cell. If an RTS is not present, if a different charger is in use, or if a different compensation factor is required, it may be necessary to adjust the charger settings manually. The RTS should be checked periodically. Failure to compensate correctly may result in wrong voltages.

Improper Use

	CAUTION: Equipment Damage Read all items below. Maintenance should be performed as noted on page 18. Failure to follow these instructions can result in battery damage which is not covered under the EnergyCell warranty.
	CAUTION: Equipment Damage Do not exceed the specified absorption voltage when charging any EnergyCell battery. Excessive voltage could result in battery damage which is not covered under the EnergyCell warranty.

For any EnergyCell battery, if the charger settings are too high, this will cause premature aging of the battery, including loss of electrolyte due to gassing. The result will be permanent loss of some battery capacity and decreased battery life. This is also true for battery charging that is not compensated for high temperatures.

“Thermal runaway” can result from high ambient temperatures, charging at higher voltages over extended time, incorrect temperature compensation, or shorted cells. When the buildup of internal heat exceeds the rate of cooling, the battery’s chemical reaction accelerates. The reaction releases even more heat, which in turn continues to speed up the reaction. Thermal runaway causes severe heat, gassing, lost electrolyte, and cell damage. It usually requires battery replacement. The process can be halted by turning off the charger. However, if cell damage has occurred, shorted cells may continue to generate heat and gas for some time.

If an EnergyCell battery is not charged completely (or if the settings are too low), it will not reach 100% SoC. Its total capacity will not be available during the next discharge cycle. This capacity will become progressively less and less over subsequent cycles. Long-term undercharging will result in decreased battery life. This is also true for battery charging that is not compensated for low temperatures.



Troubleshooting and Maintenance

Table 2 Troubleshooting

Category	Symptom	Possible Cause	Remedy
Performance	Reduced operating time	Normal life cycle	Replace battery bank when (or before) capacity drops to unacceptable levels.
		Defective cells	Test and replace battery as necessary.
	Excessive voltage drop upon applying load	Excessively cold battery	Carefully warm up the battery.
		Undersized cabling	Increase cable ampacity to match loads.
		Loose or dirty cable connections	Check and clean all connections. Physical damage on terminals may require the battery to be replaced. Replace hardware as necessary.
		Undersized battery bank	Add additional batteries to match loads.
Defective cells	Test and replace battery as necessary.		
External Inspection	Swollen or deformed battery casing; "rotten-egg" or sulfurous odor; battery is hot	Thermal runaway NOTE: A modest amount of swelling (or concavity) on the battery case is normal.	NOTE: Thermal runaway is a hazardous condition. Treat the battery with caution. Allow the battery to cool before approaching. Disconnect and replace battery as necessary. Address the conditions that may have led to thermal runaway (see page 16).
	Damaged battery casing	Physical abuse	Replace battery as necessary.
	Heat damage or melted grease at terminals	Loose or dirty cable connections	Check and clean all connections. Physical damage on terminals may require the battery to be replaced. Replace hardware as necessary.
Voltage testing	Fully-charged battery displays low voltage	High temperature	Carefully cool the battery. An overheated battery may contribute to thermal runaway.
	Fully-charged battery displays high voltage	Low temperature	Carefully warm up the battery.
	Individual battery charging voltage will not exceed 13.3 Vdc; high float current; failure to support load	Shorted cell	Test and replace battery as necessary. A shorted cell may contribute to thermal runaway.
	Individual battery float voltage exceeds 14.5 Vdc; failure to support load	Open cell	Test and replace battery as necessary.

Table 2 Troubleshooting

Category	Symptom	Possible Cause	Remedy
Current testing	Charging current to series string is zero; failure to support load	Open connection or open battery cell in string	Check and clean all connections. If battery appears to have an open cell, test and replace as needed. Replace hardware as necessary.
	Charging current to series string remains high over time	Batteries require additional time to charge	Normal behavior; no action necessary.
	Charging current to series string remains high with no corresponding rise in voltage	Shorted cell	Test and replace battery as necessary. A shorted cell may contribute to thermal runaway.

Periodic Evaluation

Upon replacement of a battery (or string), all interconnect hardware should be replaced at the same time.

To keep track of performance and identify batteries that may be approaching the end of their life, perform the following tests during on a quarterly basis following commissioning (see page 13). Tests must be made with a high-quality digital meter. Voltages must be measured directly on battery terminals, not on other conductors. All connections must be cleaned, re-tightened, and re-torqued before testing. If a battery fails any test, it may be defective. If this occurs under the conditions of the warranty, the battery will be replaced according to the terms of the warranty.

Bring the batteries to a full state of charge before performing either of the following tests.

24-Hour Open-Circuit Test

Remove all battery connections, then allow the battery to rest in this state for 24 hours. Test the battery voltage, compensating for temperature. The EnergyCell RE battery should measure 12.84 Vdc. The EnergyCell GH battery should measure 12.95 Vdc. A battery below 12.6 Vdc has lost capacity and may need to be replaced.

25-Amp Capacity Test

1. Install a DC load which draws a continuous 25 Adc. This allows the results to be correlated to the specified capacity. The load may be used on either a single battery or a full string.
2. The load test unit wires must be sized correctly. For load testing all wiring should have a minimum ampacity of 150% of the load current.
3. With this load, discharge the batteries until they have reached 10.5 Vdc per battery (1.75 Vdc per cell).
4. Monitor the elapsed time. At the same time, monitor the battery's temperature.
5. Record the temperature at the end of the test. Use the equation below to adjust the results for temperature.

$$M_c = M_r(1 - 0.009 [T - 26.7])$$

where M_r = actual elapsed minutes

T = temperature at end of run time

M_c = minutes corrected for temperature with a baseline of 80°F (26.7°C).

6. Compare M_c with the appropriate value in Table 1 on page 13. If the result is less than 80% of this number, the battery (or string) may need to be replaced.



Specifications

Table 3 EnergyCell Battery Electrical Specifications

	EnergyCell RE (all models)	EnergyCell GH (all models)
Battery Category	Valve-regulated, lead-acid (VRLA)	Valve-regulated, lead-acid (VRLA)
Battery Technology	Absorbed glass-mat (AGM)	Absorbed glass-mat (AGM)
Cells Per Unit	6	6
Voltage Per Unit (nominal)	12 Vdc	12 Vdc
Operating Temperature Range (with temperature compensation)	Discharge: -40°F (-40°C) to 160°F (71°C) Charge: -10°F (-23°C) to 140°F (60°C)	-40°F (-40°C) to 122°F (50°C)
Optimal Operating Temperature Range	74°F (23°C) to 80°F (27°C)	50°F (10°C) to 104°F (40°C)
Self-Discharge	Store up to 6 months at 77°F (25°C) before a freshening charge is required.	Store up to 18 months at 77°F (25°C) before a freshening charge is required.

Table 4 EnergyCell Front Terminal Mechanical Specifications

	170RE	200RE	200GH	220GH
Terminal	Threaded insert terminal to accept ¼"-20 UNC bolt		Threaded stud to accept M6 nut	
Terminal Hardware Initial Torque	110 in-lb (12.4 Nm)		80 in-lb (9.0 Nm)	
Weight	115.0 lb (52.2 kg)	131.0 lb (59.4 kg)	115.7 lb (52.5 kg)	132.3 lb (52.5 kg)
Dimensions (H x L x W)	11.1 x 22.1 x 4.9" (28.3 x 56.1 x 12.5 cm)	12.6 x 22.0 x 4.9" (32.0 x 55.9 x 12.5 cm)	11.1 x 22.1 x 4.9" (28.3 x 56.1 x 12.5 cm)	12.4 x 22.1 x 4.9" (31.6 x 56.1 x 12.5 cm)

Table 5 EnergyCell Top Terminal Mechanical Specifications

	34RE	52RE	78RE	95RE	106RE
Terminal	Threaded insert terminal to accept 10"-32 UNC bolt		Threaded insert terminal to accept ¼"-20 UNC bolt		
Terminal Hardware Initial Torque	30 in-lb (3.4 Nm)		110 in-lb (12.4 Nm)		
Weight	27 lb (12.2 kg)	40 lb (18.1 kg)	54 lb (24.5 kg)	64 lb (29.0 kg)	69 lb (31.3 kg)
Dimensions (H x L x W)	6.8 x 7.8 x 5.2" (17.3 x 19.7 x 13.2 cm)	8.1 x 9.0 x 5.5" (20.5 x 22.9 x 13.9 cm)	8.0 x 10.8 x 6.8" (20.3 x 27.3 x 17.3 cm)	8.1 x 12.5 x 6.8" (20.5 x 31.8 x 17.3 cm)	8.5 x 13.4 x 6.8" (21.6 x 34.1 x 17.3 cm)

Table 6 EnergyCell Charging Requirements at 77°F (25°C)

	34RE	52RE	78RE	95RE	106RE	170RE	200RE	200GH	220GH
Recommended Maximum Current Limit Per String	7 Adc	10 Adc	15 Adc	18 Adc	20 Adc	25 Adc	30 Adc	32 Adc	36 Adc
Float Charging Voltage	13.5 to 13.8 Vdc					13.62 to 13.8 vdc		13.62 Vdc	
Absorb Charging Voltage	14.4 to 14.8 Vdc							14.4 Vdc	
Temperature Compensation Factor	0.03 Vdc per battery in series (5 mV per cell) per degree C							0.024 Vdc per battery in series (4 mV per cell) per degree C	

Specifications

Ampere-Hour Capacity Based On Discharge Rate

The EnergyCell battery capacity is measured in amp-hours. The battery capacity is not a fixed number, but will vary with conditions. (See page 8.) The figures in the tables below are used to measure the capacity of the EnergyCell battery based on load size.

Battery capacity is judged by the number of amp-hours measured when a battery is discharged to a standard voltage under load. This is known in the industry as “terminal voltage”. A commonly cited terminal voltage is 10.5 volts per 12-volt battery, or 1.75 volts per cell (Vpc). Another common value is 1.85 volts per cell; this value is used when sizing batteries conservatively to avoid severely discharging them.

The amp-hours measured upon reaching terminal voltage also depend on the size of the load. A load capable of discharging the battery in 1 hour is far larger than a load which takes 3, 4, or 5 hours. (8-hour loads, 12-hour loads, etc. are progressively smaller in size.) As described on page 8, the battery has less capacity under larger loads and more capacity under smaller loads.

Table 7 shows EnergyCell capacity at a terminal of voltage 1.75 Vpc. Table 8 shows EnergyCell capacity at a terminal voltage of 1.85 Vpc.

Example: Under a 1-hour load, the EnergyCell 170RE has a capacity of only 89.1 amp-hours when measured to 1.75 Vpc in Table 7. Under a much lighter 100-hour load, the same battery has 170 amp-hours in Table 7, almost twice that amount.

Other EnergyCell batteries are measured similarly.

Table 7 Amp-Hour Capacity to 1.75 Vpc @ 77°F (25°C)

Model	Discharge in Hours														
	1	2	3	4	5	6	7	8	10	12	20	24	48	72	100
34RE	19.7	23.6	26.1	28.0	29.0	29.6	30.1	30.1	31.1	31.7	33.0	33.1	-	33.8	34.0
52RE	29.6	35.1	38.9	41.4	43.3	44.6	45.4	46.0	47.2	48.0	50.0	50.4	-	51.8	52.0
78RE	43.5	53.2	58.5	62.0	64.5	66.6	68.6	69.6	71.0	72.0	75.0	75.6	-	77.6	78.0
95RE	47.0	58.0	66.0	70.8	74.0	76.2	78.0	79.2	81.7	83.6	88.0	88.8	-	93.0	95.0
106RE	49.2	61.5	70.0	76.0	80.6	84.0	86.8	89.0	92.0	94.2	100.0	101.0	-	104.0	106.0
170RE	89.1	-	114.2	120.6	125.9	-	-	137.0	-	145.3	153.8	157.0	163.9	-	170.0
200RE	103.0	-	132.0	139.6	145.5	-	-	158.4	-	168.0	178.0	181.4	189.6	-	200.0
200GH	120.0	-	148.5	154.8	159.0	-	-	168.8	-	176.4	191.0	189.6	192.0	-	200.0
220GH	133.5	-	166.2	173.2	178.0	-	-	188.8	-	198.0	214.0	216.0	-	-	220.0

Table 8 Amp-Hour Capacity to 1.85 Vpc @ 77°F (25°C)

Model	Discharge in Hours														
	1	2	3	4	5	6	7	8	10	12	20	24	48	72	100
34RE	22.3	25.8	28.1	29.9	30.8	31.4	31.8	31.8	32.7	33.4	34.7	35.1	-	36.4	36.7
52RE	33.5	38.4	41.9	44.3	46.0	47.3	47.9	48.7	49.7	50.5	52.6	53.4	-	55.7	56.1
78RE	49.3	58.2	63.1	66.3	68.6	70.7	72.4	73.6	74.7	75.8	78.8	80.1	-	83.5	84.2
95RE	53.3	63.5	71.1	75.7	78.7	80.8	82.4	83.8	85.9	88.0	92.5	94.1	-	100.1	102.5
106RE	55.7	67.3	75.5	81.2	85.7	89.1	91.7	94.2	96.8	99.2	105.1	107.1	-	111.9	114.4
170RE	100.9	-	123.1	128.9	133.8	-	-	144.9	-	153.0	161.6	166.4	176.8	-	183.4
200RE	116.7	-	142.3	149.2	154.7	-	-	167.6	-	176.9	187.1	192.3	204.6	-	215.8
200GH	136.0	-	160.1	165.5	169.0	-	-	178.6	-	185.7	200.7	200.9	207.2	-	215.8
220GH	151.3	-	179.2	185.2	189.2	-	-	199.8	-	208.5	224.9	228.9	-	-	237.4

This page intentionally left blank.

This page intentionally left blank.

This page intentionally left blank.

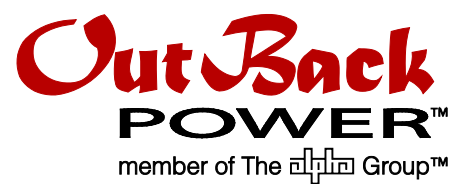

Masters of the Off-Grid.™ First Choice for the New Grid.

Corporate Headquarters
17825 – 59th Avenue N.E.
Suite B
Arlington, WA 98223 USA
+1.360.435.6030

European Office
Hansastraße 8
D-91126
Schwabach, Germany
+49.9122.79889.0